

NH-1800SE

Operator Manual

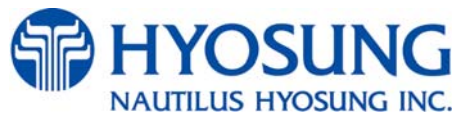

Copyright© 2010 Nautilus Hyosung Inc. All right reserved

Revision Record

Date	Page	Version	Description of Change
October, 2010	All	1.0	New Publication

Table of Contents

1. Introduction	
1.1 About NH-1800SE	1-2
1.2 Basic Features	1-2
1.3 What is in this Manual	1-3
1.4 Terminologies	1-4
1.5 Abbreviations of ATM	1-4
2. Precautions for Safety	
2.1 Overview	2-2
2.2 Description of Precaution Symbols	2-3
3. Hardware Specifications	
3.1 Dimensions	3-2
3.2 Component Locations	3-3
3.3 LCD & Customer Keypad	3-5
3.4 Cash Dispenser Unit	3-6
3.5 Receipt Printer	3-7
3.6 Magnetic Card Reader	3-8
3.7 Main Control Board	3-9
3.8 Operating Environment	3-10
4. Operating Instructions	
4.1 Opening and Closing the Door	4-2
4.2 Cash Dispenser	4-16
4.3 Receipt Printer	4-30
4.4 Magnetic Card Specifications	4-37
5. Operator Functions	
5.1 Basic System Operation	5-2
5.2 Supervisor Menu	5-19
5.3 Settlement	5-23
5.4 Journal	5-25

5.5 Report	5-28
5.6 Diagnostics	5-36
5.7 Customer Setup	5-47
5.8 System Setup	5-89
5.9 Host Setup	5-102
5.10 Transaction Setup	5-123
5.11 Site Map	5-126
5.12 Quick Replenish	5-126
5.13 Quick Configuration	5-129
6. Installation	
6.1 Installation Information	6-2
6.2 System Installation	6-3
7. Appendix	
7.1 Error Code Table	7-2
7.2 Installation Guide	7-36
7.3 Transaction Screen Flow	7-47
7.4 Supported USB Memory and HUB	7-101
7.5 Advertisement Image Update Guide	7-103
7.6 Background Image Update Guide	7-117
7.7 Weather Service Guide (NH2700 Only)	7-126

Chapter 1. Introduction

1. Introduction

1.1 About NH-1800SE

NH-1800SE is designed to meet the everyday demands of immediate cash needs for individuals with a compact size to fit in virtually any place. This Automated Teller Machine (ATM) is connected to a network processor to verify accounts and any other inquires through the insertion of a customer's card. NH-1800SE is easy to use, easy to service and able to support customer's needs.

1.2 Basic Features

Major features of NH-1800SE are highlighted in the following list:

Main Controller			
CPU		S5PC100 834MHz (ARMCortex-A8)	
Memory	SDRAM	256MB	
	Flash Memory	256MB	
	NV-RAM	512KB	Shared Flash Memory
Operating System		WinCE 6.0	
Serial Ports		8 Ports	
Communication		MODEM & TCP/IP Selectable	
Customer Display			
Display Type		8" TFT LCD	800 X 600
Flicker		4 EA (High Bright LED)	MCU, EPP, CDU, SPR
Customer Input Method			
PIN Pad		Metal Key Cap EPP	T-DES, PCI Certified
Function Key		4X2	NDC Compatible
Cash Dispenser			
Number of cassettes		1 cassette	2cassette, 3cassette Option
Denomination		\$20	\$10, \$50, \$100 Option
Maximum Dispense		40 Notes/Transaction	
Cassette Capacity		1,000Notes / Capacity (New Bill)	2K, 4K, 6K Option
Reject Type		Note by Note Reject (200 bills Max)	Reject Bin

Card Reader		
Type	DIP Type	
Magnetic Stripe	ISO 1,2 Read	EMV Option
Receipt Printer		
Printing Type	Thermal Line Printing	
Printing Width	80mm [3.15inch] Max	
Paper Setting Method	Semi-Automatic	
Paper Specification	Type	Thermal Roll Paper
	Width	Max. 80mm [3.15inch]
	Outer Diameter	Max. 180Φ
Journal Printer		
Journal Printer	Electronic Journal	
Safety		
Safety	UL Business-Hour Safety	-
Locking device	Dial Lock	Combo/Cencon Lock Option
Additional Function		
Audio guidance	Support	Speaker
ADA Audio guidance	Support	

1.3 What is in this manual

This manual contains the information needed for normal operational use.

This manual contains Unit Specifications, ATM Opening & Closing Procedures, Operator Functions, Customer Transactions, Error Recovery and etc.

Some of the information in this manual may differ according to the network processor to be connected.

1.4 Terminologies

In this manual, the terminology listed below is used as follows:

- Customer, cardholder and consumer refer to any person who makes the ATM transaction.
- Device and unit refer to the standard and optional ATM equipment, such as monitor, card reader, printer and dispenser.
- Fascia refers to the entire front portion of the unit, including the portion where the customer transacts business.
- Module refers to a plug-in device that can be serviced or replaced.
- Note(s) and bill(s) refer to the individual documents loaded into and dispensed from the dispenser.
- Screen refers to the text appearing on the customer display.

1.5 Abbreviations of ATM

NO.	Abbreviations	Description
1	AD board	Analog to Digital conversion Board
2	ADA	The American Disabilities Act
3	AP	Application Program
4	Assy	Assembly
5	BATT S/W	Battery Switch
7	CAM	Camera Unit
8	CDU	Cash Dispenser Unit
9	CE	Control Electronics
10	Earphone Jack	Voice Converter for Visually Disabled Persons (ADA)
11	EMV	Europay, Mastercard, Visa
12	EP	Elementary Program
13	EPP	Encryption PIN Pad
14	H/W	Hardware
15	I/F	Interface
16	ISO	International Standard Organization
17	ISO 1	IATA(International Air Transaction Association)

NO.	Abbreviations	Description
18	ISO 2	ABA (American Banks Association)
19	ISO 3	MINTS(Mutual Institutions National Transfer Systems)
20	JPR	Journal Printer
21	LCD	Liquid Crystal Display
22	MCU	Magnetic Card Unit
23	OPL	Operation Panel for Customers to Operate
24	OSD board	On Screen Display Board
25	P/S	Power Supply
26	PIN	Personal Identification Number
27	PNC	Panel Control Board
28	PTR	Printer (mainly Receipt Printer)
29	S/W	Switch
30	SIU	Sensor and Indications Unit
31	SP	Service Provider
32	SPR	Slip Printer (Receipt Printer)
33	TTU	Text Terminal Unit (OPL or SPL)
34	VFD	Vacuum Fluorescent Display

Chapter 2. Precautions for Safety

2. Precautions for Safety

2.1 Overview

Common Precaution for Safety



Precautions outlined this manual provide information on safe and proper handling of the product. Non-compliance of the precautions may result in injury or damage to the product.







This precaution symbol with sample term tells you safety warnings during equipment handlings.

Please read the following instructions before operating equipment.

- Operate equipment in the order outlined in this manual.
- Follow precautions indicated in this manual, as well as the equipment itself.
Failure to properly address these precautions may lead to injury or damage to the product.
- Avoid operations not addressed in this manual.
- If you cannot remedy system problems using the methods outlined in this manual, please refer to contact information listed in the manual.
- Any change or modifications in construction of this device which are not expressly approved by the party responsible for compliance could void the user's authority to operate the equipment.

NOTE: This equipment has been tested and found to comply with the limits for a Class A digital device, pursuant to part 15 of the FCC Rules. These limits are designed to provide reasonable protection against harmful interference when the equipment is operated in a commercial environment. This equipment generates, uses, and can radiate radio frequency energy and, if not installed and used in accordance with the instruction manual, may cause harmful interference to radio communications. Operation of this equipment in a residential area is likely to cause harmful interference in which case the user will be required to correct the interference at his own expense.

2.2 Description of Precaution Symbols

Symbol	Description
	<p>Electrical Shock</p> <ul style="list-style-type: none"> • Do not remove cover. Only a maintenance engineer is allowed to open the cover. • Do not touch. You may receive electric shock. • Make sure to turn off the power when servicing the equipment.
	<p>High Temperature</p> <ul style="list-style-type: none"> • Do not touch the equipment when it is running. • The equipment can get extremely hot and may cause a burn. • Make sure to close the cover before running the equipment.
	<p>Be Careful when Moving</p> <ul style="list-style-type: none"> • The equipment is heavy. Make sure at least 2 people to lift or move the equipment. • Do not attempt to move the equipment alone. You may be injured by dropping the heavy equipment.
	<p>Fire Hazard</p> <ul style="list-style-type: none"> • Place the equipment in an area away from any combustible materials. • The equipment may catch on fire from overheating or short circuit of the power supply unit.
	<p>Disassembly</p> <ul style="list-style-type: none"> • Do not disassemble or modify the equipment unless you are a certified engineer. • Contact the service center for maintenance, adjustments and repairs. • Improper disassembly may cause fire or electrical shock.
	<p>Fall down</p> <ul style="list-style-type: none"> • Do not place the equipment where the floor cannot sustain the weight of the equipment, or on slanted or unstable surface. • Equipment may fall down and cause injury or damage.

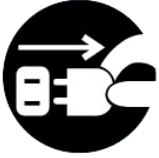
Symbol	Description
	<p>Unplug the Equipment</p> <ul style="list-style-type: none"> • Stop using the equipment immediately if it smokes, emits an unusual smell, makes abnormal sounds, or if liquids or other foreign materials enter the equipment. • If the above-mentioned abnormalities occur, immediately turn off the power, unplug the equipment and contact the service center. • If you ignore these symptoms, the equipment may catch on fire or cause electric shock.

[CAUTION!]

1. TO REDUCE THE RISK OF FIRE, USE ONLY No. 26 AWG OR LARGER TELECOMMUNICATION LINE CORD
2. RISK OF EXPLOSION IF BATTERY IS REPLACED BY AN INCORRECT TYPE. DISPOSED OF USED BATTERIES ACCORDING TO THE INSTRUCTIONS
3. FOR PLUGGABLE EQUIPMENT, THE SOCKET-OUTLET SHALL BE INSTALLED NEAR THE EQUIPMENT AN SHALL BE EASILY ACCESSIBLE
4. THE EQUIPMENT IS TO BE SECURED TO THE BUILDING STRUCTURE BEFORE OPERATION

Chapter 3. Hardware Specifications

3. Hardware Specifications

3.1 Dimensions

Below figures show the overall physical dimensions of NH-1800SE.

NOTE: All the units in the dimension is mm and () is inch scale.

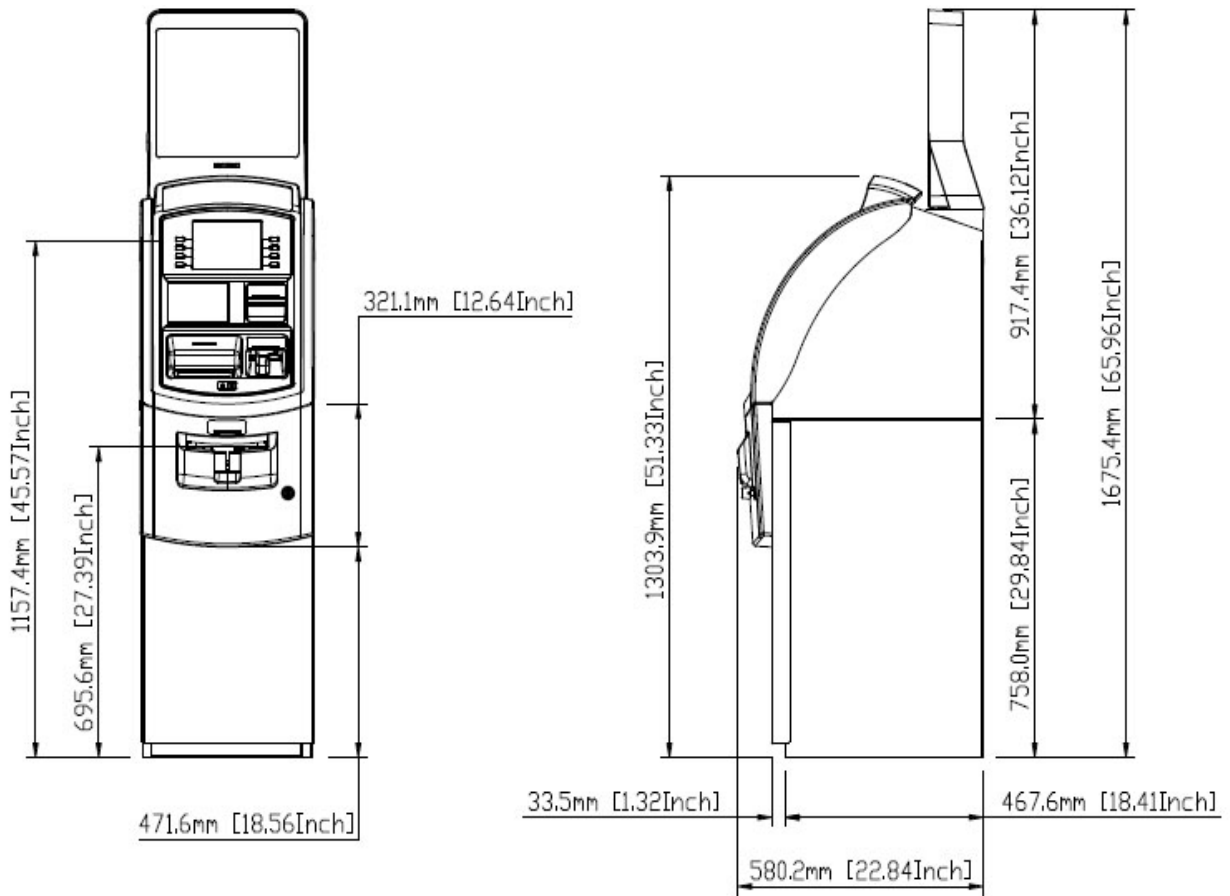

Fig. 3.1 NH-1800SE Dimension

3.2 Component Locations

Front View



Fig. 3.2 (a) Component Location (Front)

1	Liquid Crystal Display (Customer Display)	4	Card Reader Slot (Dip Type)
2	Function Keys	5	Encryption Pin Pad
3	Receipt Printer Slot	6	Cash Dispenser

Customer Display

The customer display welcomes the customer and provides the instructions for performing transactions at the terminal. An optional touch screen display eliminates the need for function keys.

Function keys

The function keys are made up of four keys mounted on each side of the customer display. The customer selects from the choices shown on the customer display and presses the corresponding function key.

Receipt Printer Slot

After the customer uses ATM, the receipt printer prints the transaction information on a form. ATM presents the form through the receipt printer slot on the upper fascia.

Customer keypad (Encryption PIN Pad)

During the transaction sequence, ATM prompts the customer to use the customer keypad to enter transaction information. The 16-key keypad uses a security module and encrypting PIN pad technology to secure the information entered by the customer at the keypad.

Dip Card Reader

The dip card reader is a manually operated device mounted directly to ATM fascia. The cardholder inserts an ATM card in the card entry slot and then removes the card to begin the transaction. The dip card reader can read magnetic stripe cards and memory chip cards. The dip card reader cannot retract, capture, or retain cards.

Cash Dispenser

When the cardholder requests cash, it is presented through the cash dispenser in the lower fascia.

3.3 LCD & Customer Keypad

The customer display welcomes the customer and provides instructions for performing transactions at ATM.

During the transaction sequence, ATM prompts the customer to use the customer keypad to enter transaction information. The 16-key keypad uses a security module and encryption PIN pad technology to secure the information entered by the customer at the keypad.

The function keypads are made up of four keys mounted on each side of the customer display. The customer selects from the choices shown on the customer display and presses the corresponding function key.



Fig. 3.3 LCD & Customer Keypad

Basic Specification of LCD

- Screen Size : 8.0 "
- TFT Color LCD
- Resolution : 800 × 600 pixels

Basic Specification of Keypad

- 10 Alphanumeric , ◀ , ▶ , ENTER, CLEAR, CANCEL, BLANK Keypads
- 8 Function Keys
- Each Keypads has integral raised Braille symbols

3.4 Cash Dispenser Unit

The cash dispenser delivers media (cash) to the cardholder after the cardholder’s request is processed by the network and the software. The media is drawn from the cassettes and transported to a slot in the fascia of ATM, where the cardholder can receive it. If the media is too mutilated or wrinkled to dispense, or if a multiple pick occurs, the dispenser sends the notes to the reject bin.

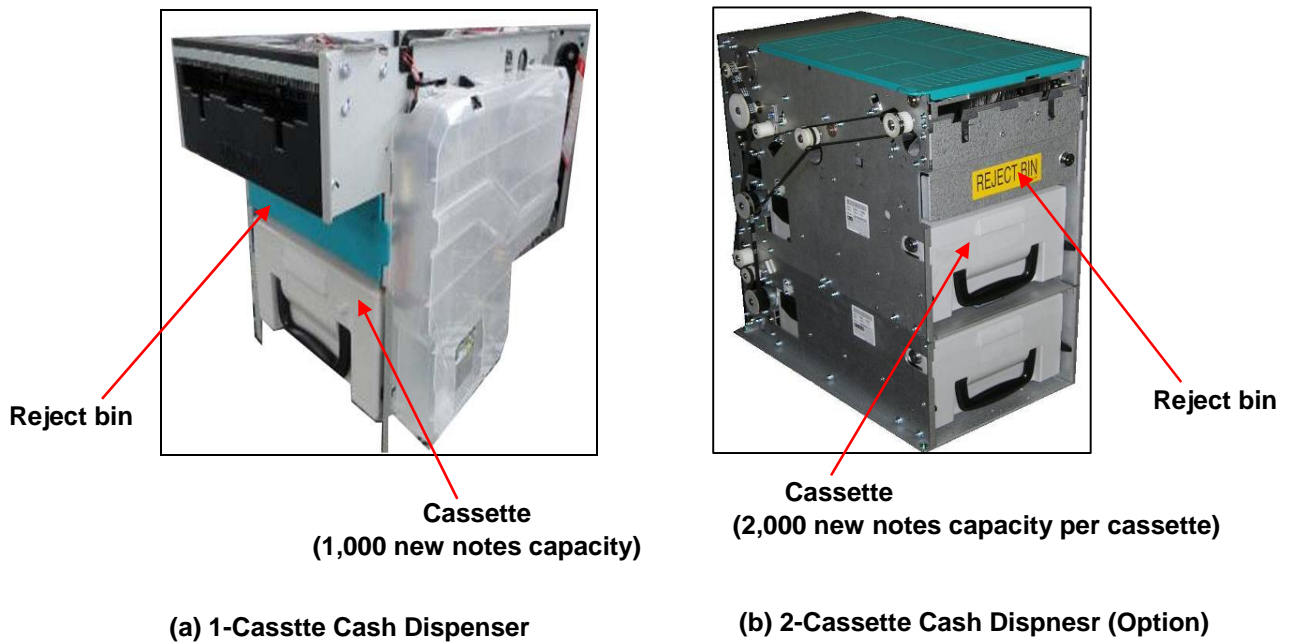

Fig.3.4 Cash Dispenser

Basic Specification of Cash Dispenser Unit

- Capacity of 1,000 new notes
- 40 notes/ transaction
- 1000/2000/4000/6000 new notes (optional)
- Reject bin with capacity of 200 notes
- Note by note reject

3.5 Receipt Printer

The receipt printer provides a printed receipt of the customer's transaction.

The transaction information can include the amount, ATM number, location and other desired information.



Fig. 3.5 Receipt Printer

Basic Specification of Receipt Printer

- Thermal line printer with cutter
- Semi-Automatic roll paper setting
- Printing Width is 80mm [3.15inch] Max

3.6 Magnetic Card Reader

The dip card reader is a manually operated device mounted directly to ATM fascia. The customer inserts an ATM card in the card entry slot and then removes the card to begin the transaction. The dip card reader can read magnetic stripe cards and memory chip cards. The dip card reader cannot retract, capture, or retain cards.



<Dip Type Card Reader>



<Card Reader supporting IC Card>

Fig. 3.6 Magnetic Card Reader

Basic Specification of Magnetic Card Reader

- Dip type Card Reader (ISO Track 1 & 2)
- EMV Level1 and 2 compliance (optional)

3.7 Main Control Board

This motherboard is applied to NH-1800SE based on Window CE.



Fig. 3.7 Main Controller

Basic Specification of Control Electronics

- S5PC100 834 MHz (ARM Cortex-A8) CPU
- SDRAM (256MB), Flash Memory (256 MB)
- Operating system : Windows CE 6.0
- Serial ports : 8 Ports
- Communication : Modem & TCP/IP Selectable

3.8 Operating Environment

Power Requirements

100 ~240 Vac \pm 10% 3.2A 50/60Hz , 100 Watt

Power Connections

NH-1800SE must be connected to a dedicated power circuit. This circuit must consist of **LINE**, **NEUTRAL** and **GROUND** leads connected directly to the power circuit breaker panel. This circuit cannot be shared with any other equipment.

Temperature

- In storage : -10°C ~ 60°C (14°F - 140°F)
- While operating : 5°C ~ 40°C (41°F - 104°F)

Humidity

- In storage : 10% < RH < 90%, Non-Condensed
- While operating : 25% < RH < 85%, Non-Condensed

Chapter 4. Operating Instructions

4. Operating Instructions

4.1 Opening and Closing the Door

4.1.1 Opening and Closing the Front Panel



1) Insert the Front Panel key and turn it clockwise.



2) Please pull the Front Panel outward.

3) Use the reverse order of above description to close the Front panel.

4.1.2 How to open the security door



1) Turn the security cover key clockwise to open the security cover.

Security Cover Key



2) Unlock the dial lock referring to “4.1.3 How to open the dial lock.”

Dial Lock

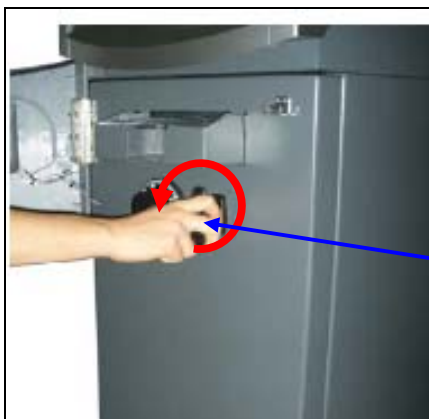

3) Turn the security door handle counterclockwise, and then pull the security door to open it.

Security Door Handle

4) Use the reverse order of above description to close the security cover and door.

4.1.3 How to open the dial lock

Make sure that this lock would be set 50-25-50 as factory default setting.

- 1) Turn to the counterclockwise for more than four times and set to "50."
- 2) Turn to the clockwise and stop at "25" at the third times.

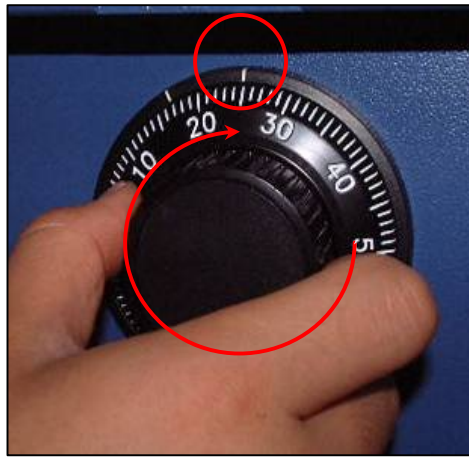

- 3) Turn to the counterclockwise and stop at "50" at the second times.
- 4) Turn to the clockwise until the dial does not move any more.

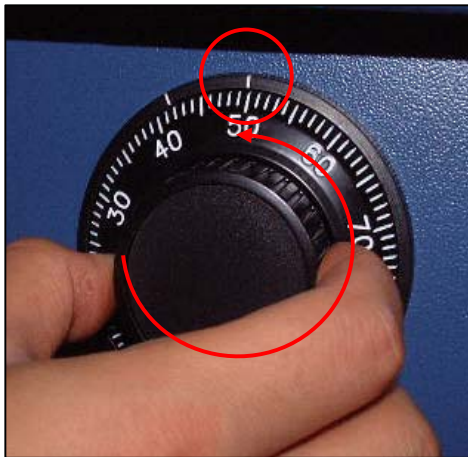

NOTE: The center scale mark is used to open the safe unit

- 5) The safe door will open when turning the handle to counterclockwise.

4.1.4 How to set the new password

For example, let's assume that you would like to set the following number (10-50-70)

- 1) Open the safe door as described in the above.
- 2) To close the mechanical lock, turn the handle to clockwise with the door opening
- 3) Turn to the counterclockwise for more than four times and set to "50" at left scale indicator as shown in the Fig.4.1.
- 4) Turn to the clockwise and stop at "25" at the third time as shown in the Fig.4.2.
- 5) Turn to the counterclockwise and stop at "50" at the second times as shown in the Fig.4.3.

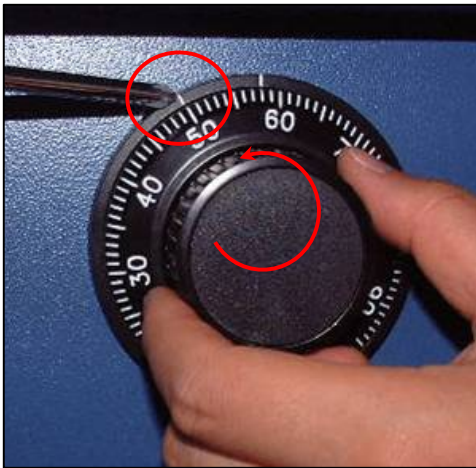

Fig.4.1

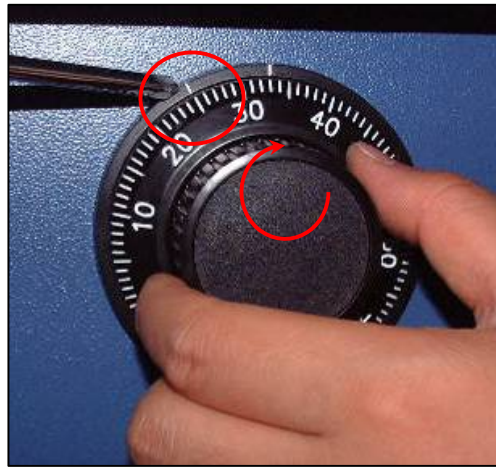

Fig.4.2

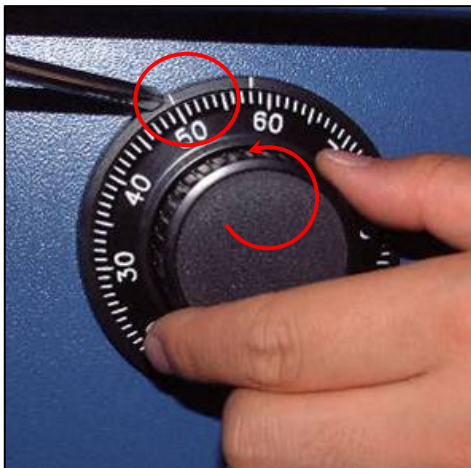

Fig.4.3

NOTE: The left scale mark is used to change the password.

- 6) Push the change bar completely until it is held by the dial change home (Fig.4. 4) inside the safe door and turn to the clockwise by 90 degrees (Fig.4.5).

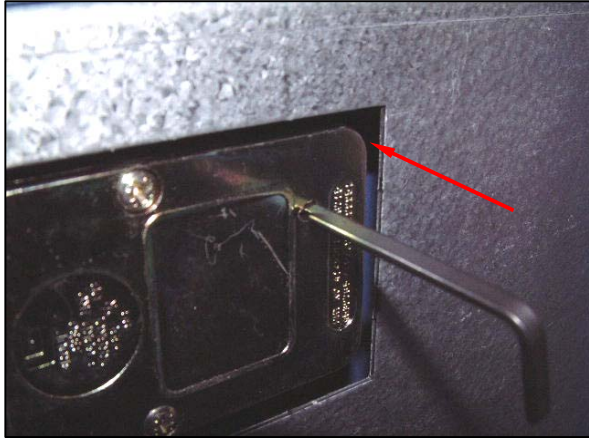

Fig.4.4

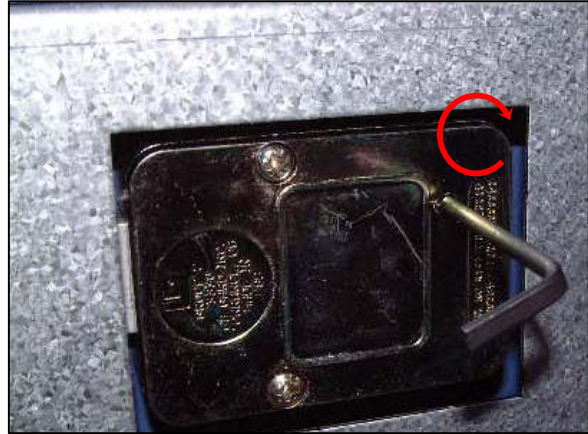

Fig.4.5

- 7) Turn to the counterclockwise more than four times and position at left scale indicator to “10” (target number to change).
- 8) Turn to the clockwise for three times and position the scale to “50” (target number to change).
- 9) Turn to the counterclockwise for two times and position the scale to “70” (target number to change).

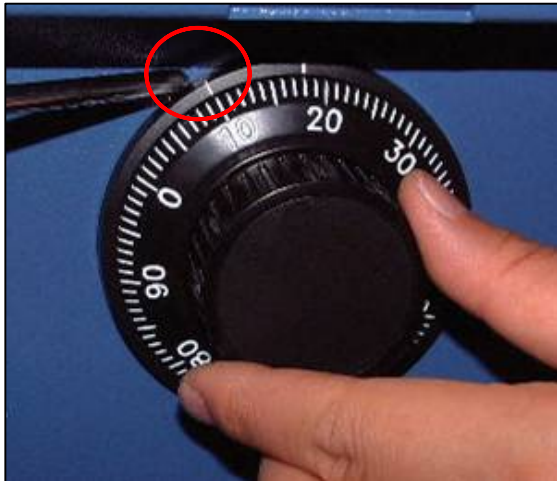

Fig.4.6

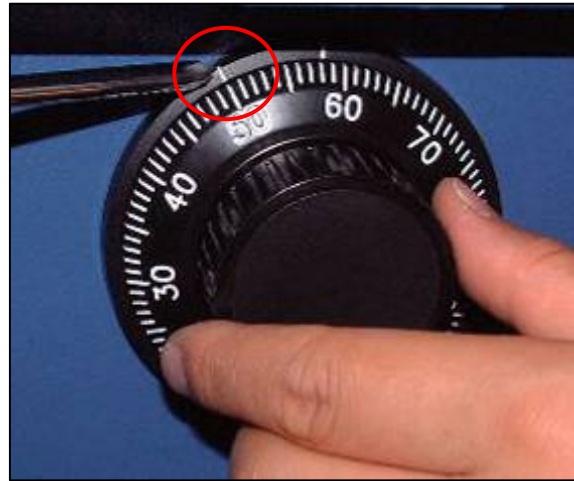

Fig.4.7

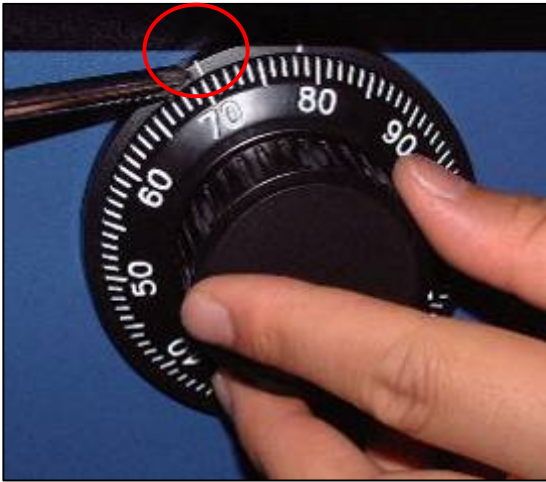

Fig.4.8

NOTE: Do not use number 25 – 35 as the last password number.

10) When password setting is completed, turn the change bar counterclockwise and remove it from the safe as shown in the Fig.4.9.



Fig.4.9

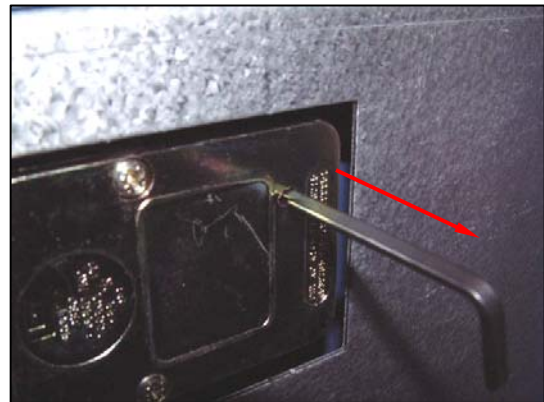

Fig.4.10

- 11) When password setting is completed, try to turn the dial more than a couple of times while the door is open to see if the door is opened or not. (Make sure to run the open/close test for at least two or three times.)
- 12) When all setting is completed, inform the password to the person in charge while paying attention to password disclosure or lost.

NOTE: Special attention must be paid and lost dial number cannot be restored.

Option A : Electronic Lock

How to open the electronic lock



- 1) Enter the password for the electronic combination lock.
(Default setting value : 123456)
- 2) Turn the electronic lock to the 90 degree clockwise as shown in left picture
- 3) Then turn the handle clockwise and open the safe door.

How to close the electronic combination lock



- 1) Close the Safe Door and turn the handle counterclockwise. The Safe Door will be locked in 5~6 seconds automatically.
- 2) Turn the electronic lock to the 90 degree counterclockwise as shown in left picture.
- 3) Then the safe door will be closed.

How to set the new password

- 1) Enter **0-0-0-0-0-0**, six (6) zeros, into the Electronic Lock keypad.
- 2) Enter in the old combination once.
- 3) Enter in the new combination twice. Combinations must be six digits in length.
- 4) If a mistake is made wait thirty (30) seconds and repeat steps 1. - 3.
- 5) Test locks operation several times before closing the door.
 - Valid Code Entry - Double signal after valid six (6) digit code is entered.
 - Invalid Code Entry - Triple signal and old code is still valid.

NOTE: The Electronic Lock will signal three (3) times if the new combination is invalid and the old

combination has been retained

LOW BATTERY WARNING

- Repeated audio and visual signal (LED flashing and repeated beeping) during opening indicates battery low.

AUDIO AND VISUAL SIGNAL

- Double signal (LED flashes and unit beeps) indicates entry is valid or accepted.
- Triple signal indicates invalid or not accepted.

WRONG TRY PENALTY

- Entry of four (4) consecutive invalid codes starts a 5-minute delay period.
 - LED flashed red at five (5) second intervals.
- At the end of the delay period, two more consecutive invalid codes will restart an additional 5-minute delay period.



[WARNING!] ALWAYS PERFORM THIS OPERATION WITH THE DOOR OPEN

BATTERY LOW WARNING

- Repeated beeping during an opening indicates that the battery is low and needs immediate replacement.
- Uses one (1) 9-Volt Alkaline Battery. LA GARD recommends the use of Duracell™ or Everready™ Alkaline batteries. If battery is depleted and will not allow lock to open, simply follow instructions below.

CHANGING YOUR BATTERY

NOTE: Some manufacturers use a small screw to secure the battery compartment cover to the keypad housing. If your model has this screw, it must be removed first before following the steps listed below.

- 1) Remove black plastic battery compartment cover (located at the bottom of the keypad) by gently pulling downward on its handle.

- 2) Allow the battery and it's attached leads to drop down and out of the battery compartment. If it does not drop, gently pull on the battery until it does.
- 3) The connector is easily removed by unsnapping it from the two terminals on the top of the battery.
Never Pull on the Battery Leads
- 4) Connect a new 9-Volt Alkaline battery to the battery clip.
- 5) Push the battery and the leads completely up into the battery compartment.
- 6) Install the battery cover by placing one side of the cover in position and then pressing the other side into position with your finger.

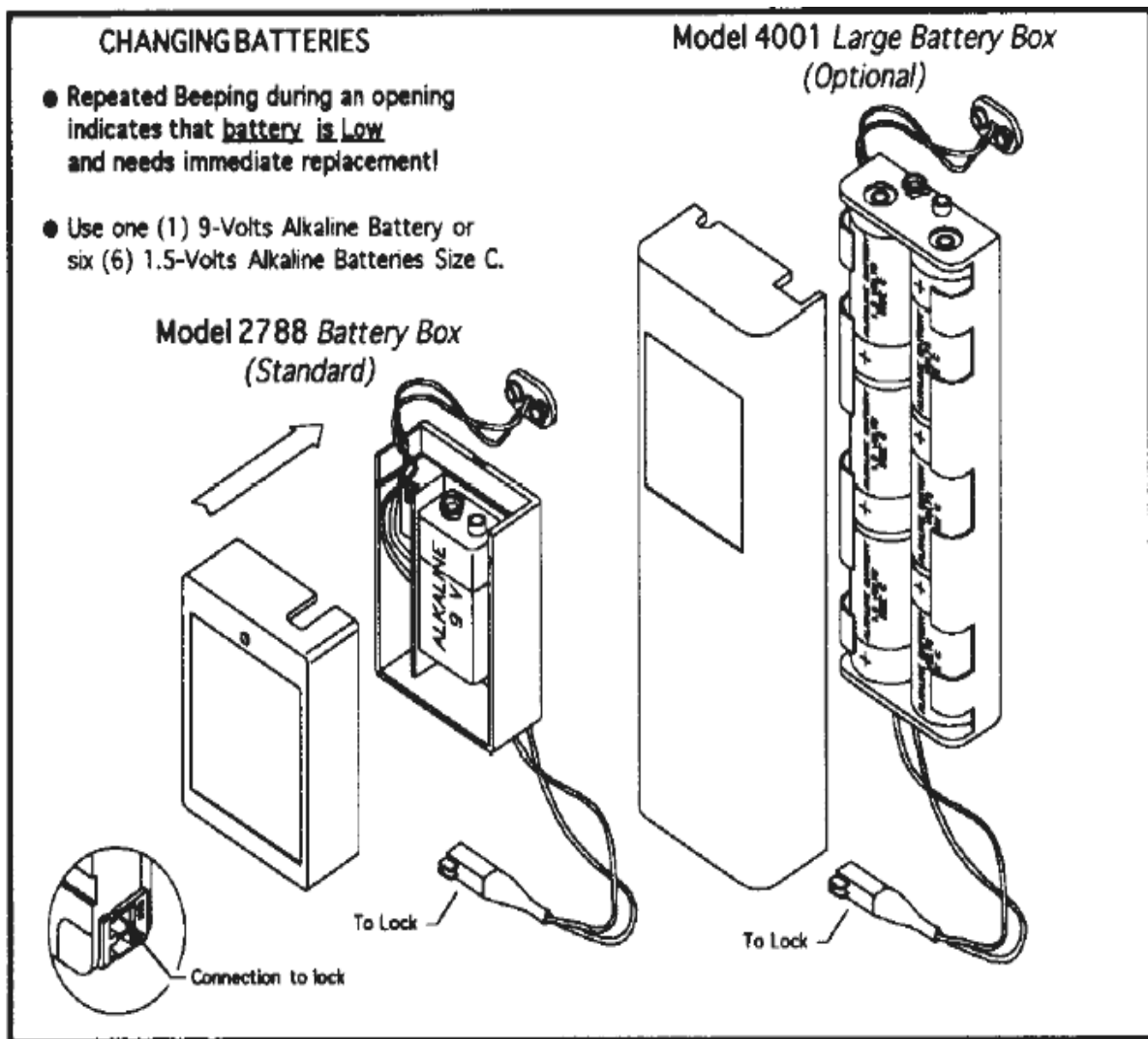

Fig. 4.11 Changing Battery #1

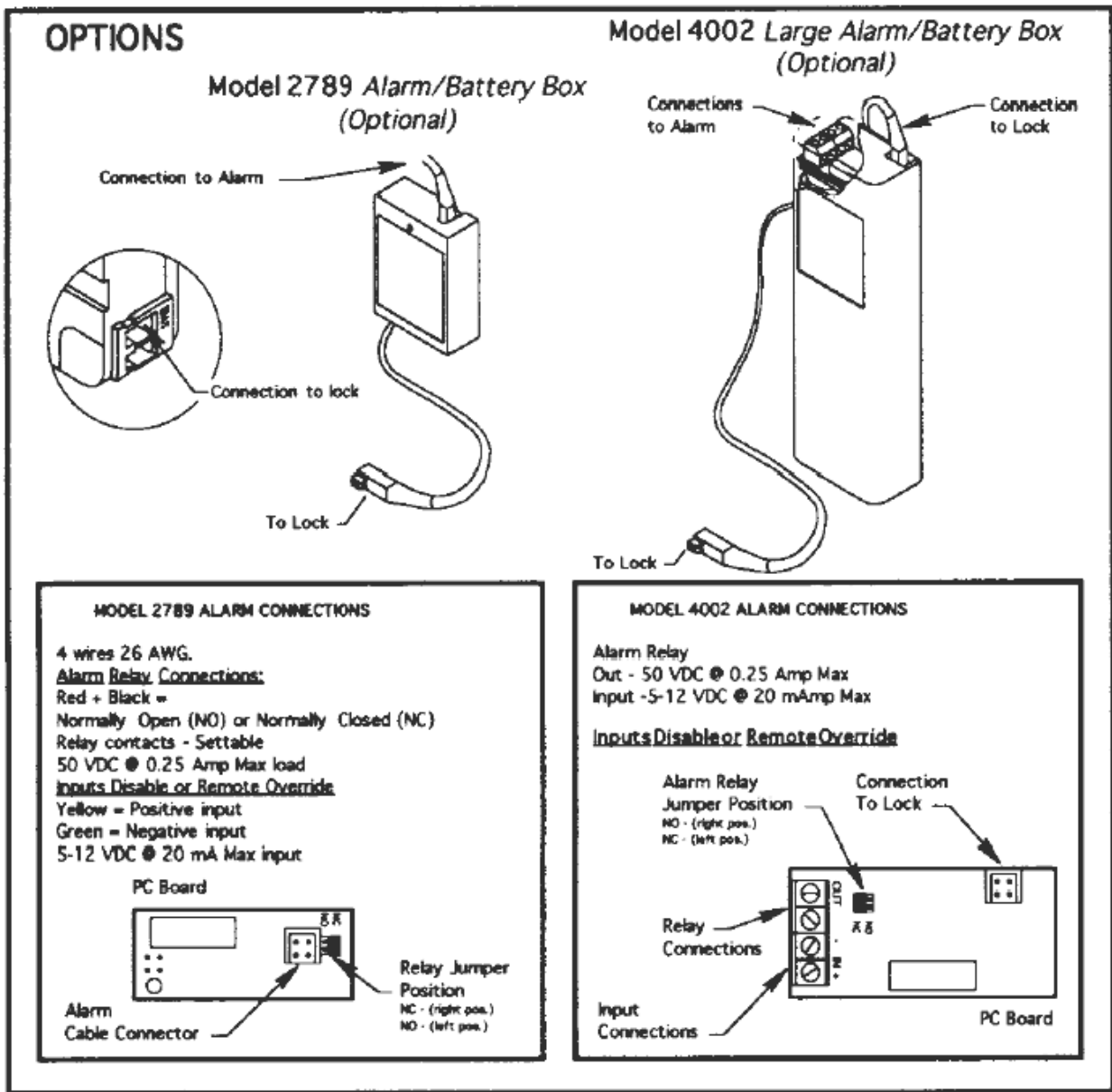

Fig. 4.12 Changing Battery #2

Option B. Cencon Lock

Initial Operating Instructions

Each lock is shipped from the factory in Shelved Mode, operating on a standard combination (50-25-50). The “one time only” combination does not function when the lock is in this condition. The correct opening procedure for a new lock is:



- 1) Insert the key into the lock and turn it clockwise to open the front bezel.



- 2) Continue the turning the Dial to left (CCW) and right (CW) until the letters “EC” appear on the LCD.

NOTE : CW (Clockwise)
CCW (Counterclockwise)



- 3) Enter the factory combination of 50-25-50 by sequentially pressing those six buttons. The LCD will display these numbers as they are entered.



4) When the combination has been correctly entered, the LCD will read :OPr” meaning “Open right.”



5) Turn the Dial right (CW) until it stops. The lock’s bolt is now retracted and the lock is open.

6) Turn the handle left (CCW) and opens the door.



7) Turning the dial left (CCW) will extend the lock’s bolt to close the door.

NOTE: Please try several times until you are comfortable with the operation of the lock.

Change Shelved Mode Combination

For System 2000 Locks with a code level of 71, or greater, you may change the Shelved Mode combination. You may change the default Factory Combination of 50-25-50 to a new combination to be used while the lock is still in Shelved Mode. Once you have changed the combination for the first time, you may want to change the combination again to a different Shelved Mode combination. You can even change it back to the Factory combination of 50-25-50

Required Items: Change Key, Current Shelved Mode Combination

NOTE: You can only change the Shelved Mode combination while operating in Shelved Mode. Once a lock is "activated" in any mode, the Shelved Mode combination returns to the Factory Default of 50-25-50

To change the Shelved Mode combination:

1) Power Lock -> EC

Turn the Dial to the left (CCW) until "EC" (Enter Combination) is displayed.

2) EC -> Enter Shelved Mode Combination -> OPr

Enter the current Shelved Mode combination (either 50-25-50 or a changed Shelved Mode combination) by sequentially pressing those digits on the lock keypad. The numbers will be displayed on the LCD as they are entered.

3) OPr -> Retract Bolt

Turn the Dial to the right (CW) to retract the bolt

4) Open Door

5) Insert Change Key

Insert the change key into the change key socket on the back of the lock.

6) Extend Bolt

Turn the Dial to the left (CCW) to extend the bolt. Do not close the door

7) Power Lock -> 

Turn the dial to the left (CCW) until  (the Change Key symbol along with Enter Combination) is displayed

8)  -> Press #8 -> EcF

Press the “#” button followed by the “8” button. EcF (Enter current Factory combination) will be displayed.

9) EcF -> Enter Current Shelved Mode Combination -> EnF

Enter the current shelved mode combination; “EnF” (Enter new Factory combination) will be displayed.

10) EnF -> Enter New Combination -> Cnf

Select and enter the new combination. “CnF” (confirm new Factory combination) will be displayed

11) Cnf -> Enter New Combination -> POC

Enter new combination again to confirm. POC (Pull Out Change key) will be displayed.

12) POC -> Remove Change Key -> EOP

Remove the change key. EOP (End Operation) is displayed.

13) EOP -> Power Lock -> EC

Turn the dial to the left (CCW) until EC (Enter Combination) is displayed.

14) EC -> Enter New Shelved Mode Combination -> OPr

Enter the new shelved mode combination by pressing those digits on the lock’s keypad. The numbers will be displayed on the LCD as they are entered

15) OPr -> Retract Bolt

Turn the Dial to the right (CW) to retract the bolt.

16) Close Door

17) Extend Bolt

Turn the Dial to the left (CCW) to extend the bolt.

4.2 Cash Dispenser

4.2.1 Bill Conditions

Acceptable condition

- 1) Bill which is very clean and can readily is recognized as a true bill

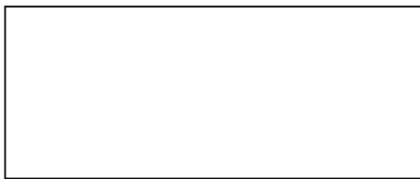

- 2) Bill has sufficient life or sizing to be handled easily



- 3) Bill which can be manually held straightly when one end is held by a hand and the bill are slightly curved vertically

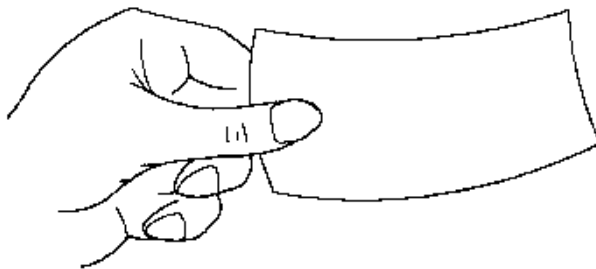

Unacceptable condition

1) Bill having serious wrinkles, torn or broken section wherein paper fiber is broken and separation begins.

- ✓ Wrinkle

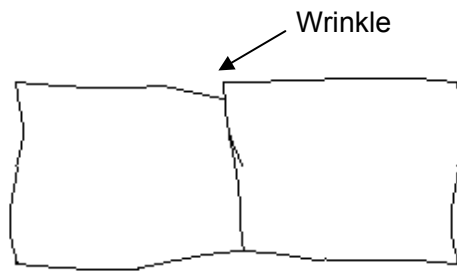

- ✓ Torn

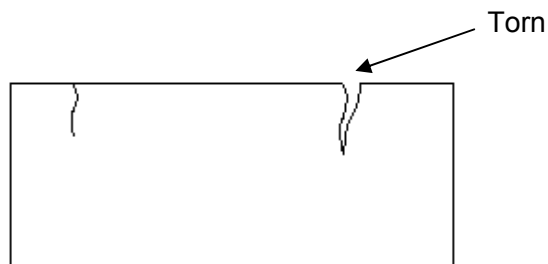

- ✓ Broken section

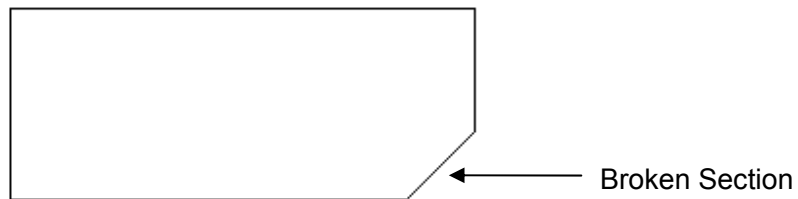

2) Bill having adequate life or sizing, but stained seriously

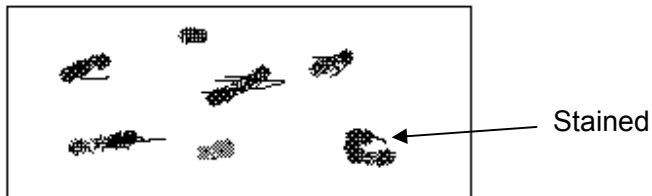

3) Bill with holes (Perforated bill)



4) Bill ragged and cannot be held straightly when one end is supported by a hand

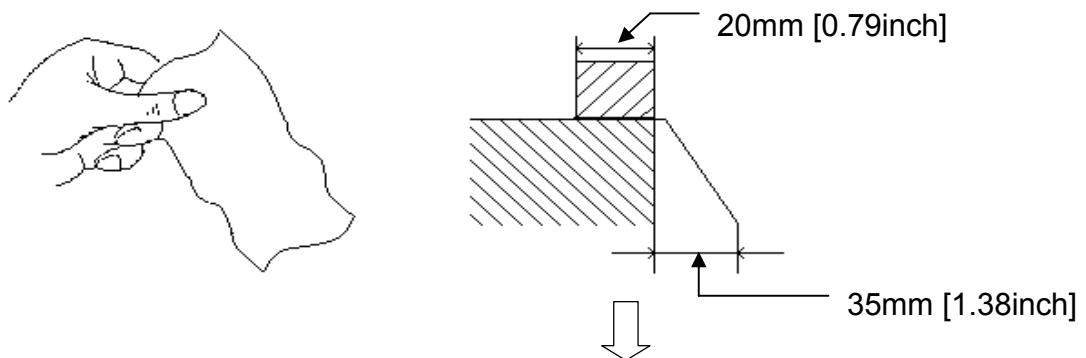

When the bill is held by 20mm [0.79inch] and the straightness of the bill is 35mm [1.38inch] or less, it cannot

5) Bill with cellophane tape, scotch tape, etc

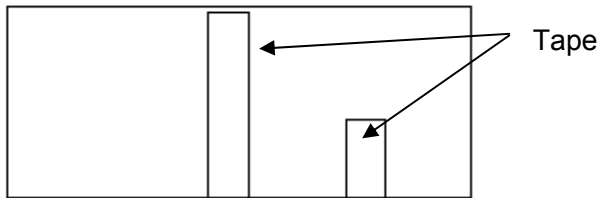

6) Bill with folds

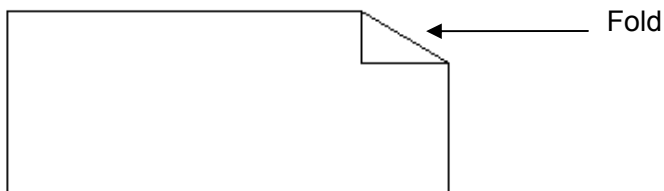

7) Gradually curved bill (bills tied by hand seal, etc)

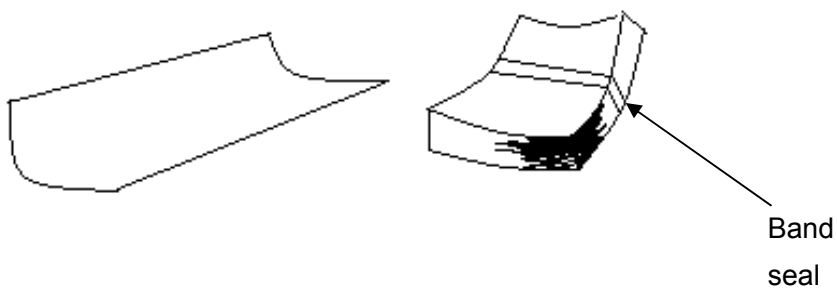

8) Bill with folded lines

✓ Case 1

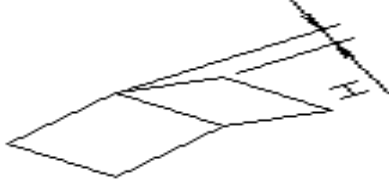

✓ Case 2



✓ Case 3



☞ Bill distortion should not exceed 10 mm [0.39inch]

Prior to replenishing the cash cassette with the notes,

- 1) Fan the notes so that the notes are not sticking together.
- 2) Remove all notes with holes or notes that are torn.
- 3) Unfold the folded notes.
- 4) Place the notes correctly.

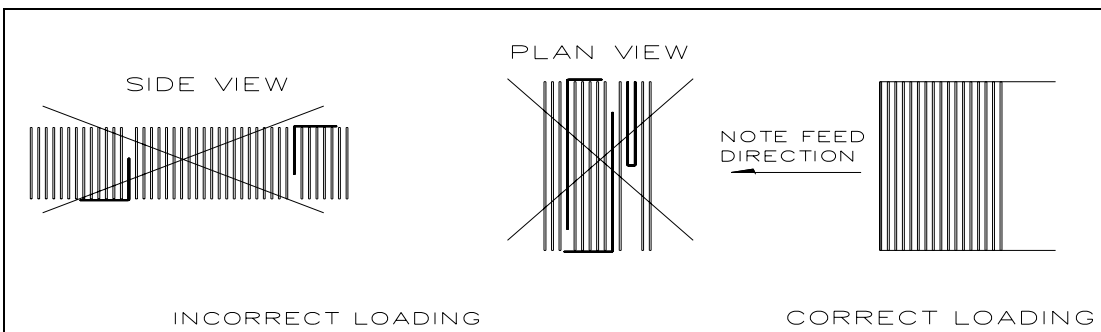

4.2.2 How to Replenish the Cash Cassette



- 1) Open the Security Cover and Door.
(Please see 4.1. Opening and Closing the Door.)



- 2) With one hand holding the cash cassette handle and the other hand supporting the cash cassette from the bottom, pull it out carefully.



- 3) Place the cash cassette on a flat level platform and turn the cassette key clockwise to unlock the cassette cover. Then lift the cassette cover.

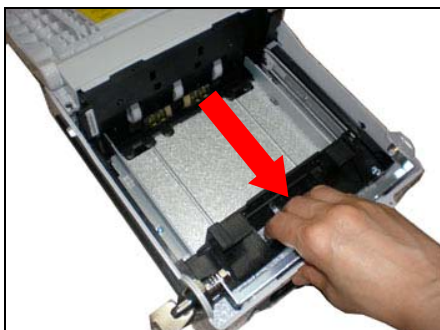

- 4) Pull the cash plate back until it is locked against the cash plate latch. And then, replenish the cash cassette. (Refer to note below.)



5) After replenishing the cash cassette, release the cash plate from the cash plate latch and allow it gradually to take up its position behind the notes.

6) After closing the cassette cover, turn the key counterclockwise



7) With one hand holding the cash cassette handle and the other hand supporting the cash cassette from the bottom, place the cash cassette carefully on the set guide of the Cash Dispensing Unit and push it in until it is locked in place.

8) And then close the security door.

4.2.3 How to Empty the Reject Bin

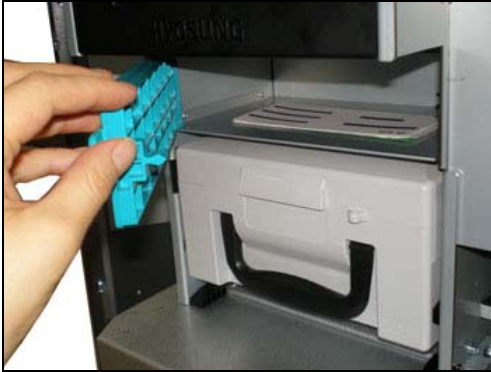

1) Open the reject bin cover.



2) Remove the notes in the reject bin and close the reject bin cover.

[PRECAUTION!]

Don't recycle any bill in reject box into cassette.

Doing so will cause not only the same reject problem, but other unexpected problems such as note jam on cash dispenser

4.2.4 How to Clear Jam

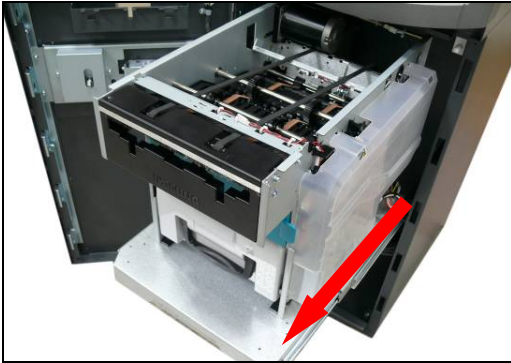

1) Turn power off first.

Pull the rail on the bottom of the cash dispenser outward.

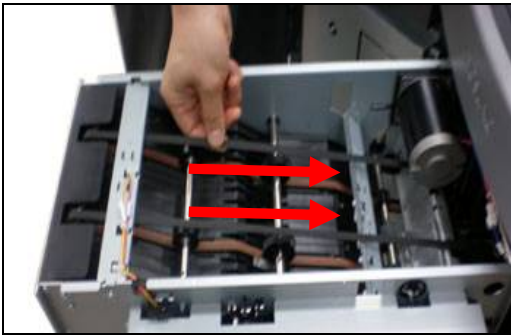

2) Move the belt in order to move jammed note into a well removed position

3) Take out the jammed note carefully.

[WARNING!]

If the belt is detached from the Roller, the lifespan of the belt can be dramatically reduced which can result in breakage. Therefore, it is extremely important to check if the belt is positioned correctly after removing the jammed bills.

Option A. Cash Dispenser with 2 Cassettes

A.1 How to Replenish the Cash Cassette



- 1) With one hand holding the cassette handle and the other hand supporting the cash cassette from bottom, pull it up and out carefully.



- 2) Place the cash cassette on a flat level platform and turn the cassette key clockwise to unlock the cassette cover. Then lift the cassette cover.

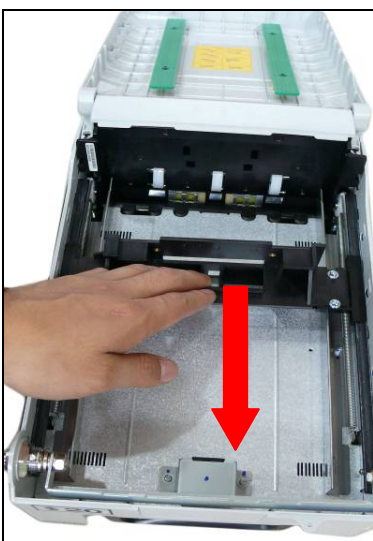

- 3) Pull the cash plate back until it is locked against the cash plate latch.

[PRECAUTION!]

Be careful not to hurt your hands when the black push-plate fails to get locked and suddenly recovers its positions



4) Replenish the cassette (Take note as below)

[PRECAUTION!]

Don't replenish more cash than recommended capacity. It means that it should be replenished less than 2,000 bills per cassette for new bills. Make sure that Cash Low Bracket in cassette will not be extruded outside cassette after replenishing cash.

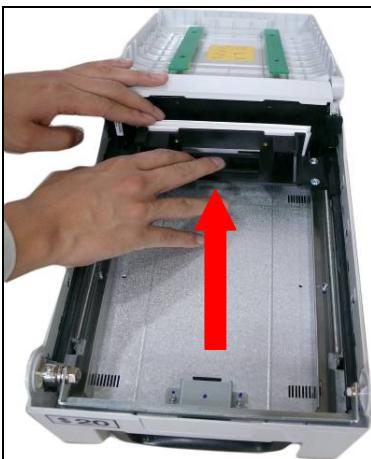

5) Unlock the cash plate by pulling it again and move it smoothly.

NOTE:

1. Fan the notes so that the notes are not sticking together.
2. Remove all notes with holes or notes that are torn.
3. Unfold the folded notes.
4. Place the notes correctly.

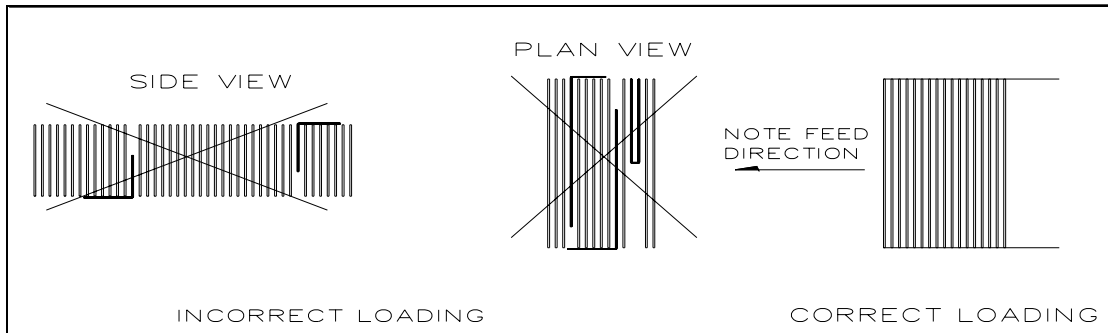

- 6) Close the cassette cover and turn the cassette key counterclockwise until it is locked. Remove the key when it is locked.



- 7) With one hand holding the cassette handle and the other hand supporting the cassette from the bottom, place the cassette carefully on the set guide of the CDU and push it in until it is locked in place.

A.2 How to Empty the Reject Bin



- 1) Insert the reject box key, turn it clockwise.
- 2) Open the lid of reject box.



- 3) Take bills from the reject box and close the box with key.

[PRECAUTION!]

Don't recycle any bill in reject box into cassette. Doing so will cause not only the same reject problem, but other unexpected problems such as note jams on cash dispenser

A.3 How to Clear Notes Jam

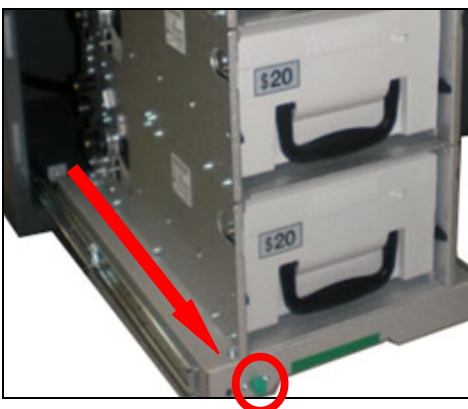

- 1) Turn power off first and pull the rail of CDU outward while pressing the green button on the CDU.

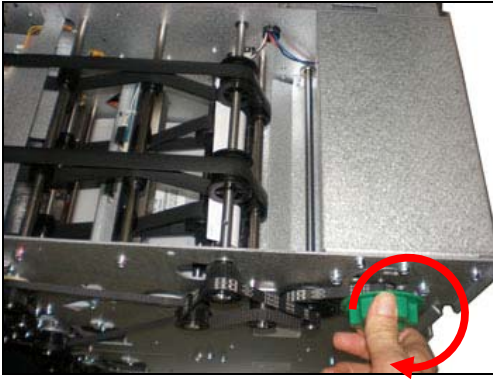

- 2) Turn the pulley located in left upper in order to move jammed note into a well removed position.

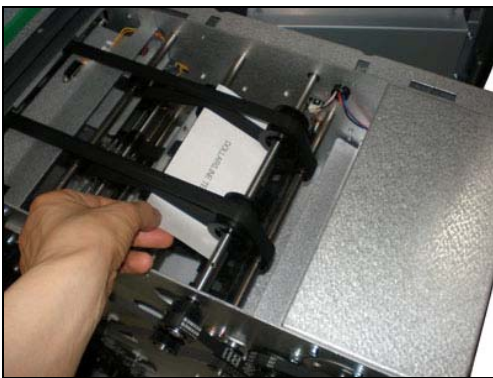

- 3) Take out the jammed note carefully.



- 4) Remove the cash cassettes to check whether there is any jammed note inside of CDU body. If so, remove the jammed note from it.

[WARNING!]

If the belt is detached from the Roller, the lifespan of the belt can be dramatically reduced which can result in breakage. Therefore, it is extremely important to check if the belt is positioned correctly after removing the jammed bills.

4.3 Receipt Printer

4.3.1 Receipt Paper

Specifications

Item	Specifications	Remark
Paper Type	Thermal Roll Paper	Paper detects heat.
Paper Width	79.5mm [3.13inch] ± 0.5mm [0.020inch]	
Paper Exterior	Ø180	
Paper basis Weight	55 [0.121lb] ± 3 [0.006lb] g/m ²	
Paper Thickness	58±4 μm	
Print Color	Black	
Type of Paper Setting	Semi-Auto loading	

Roll appearance

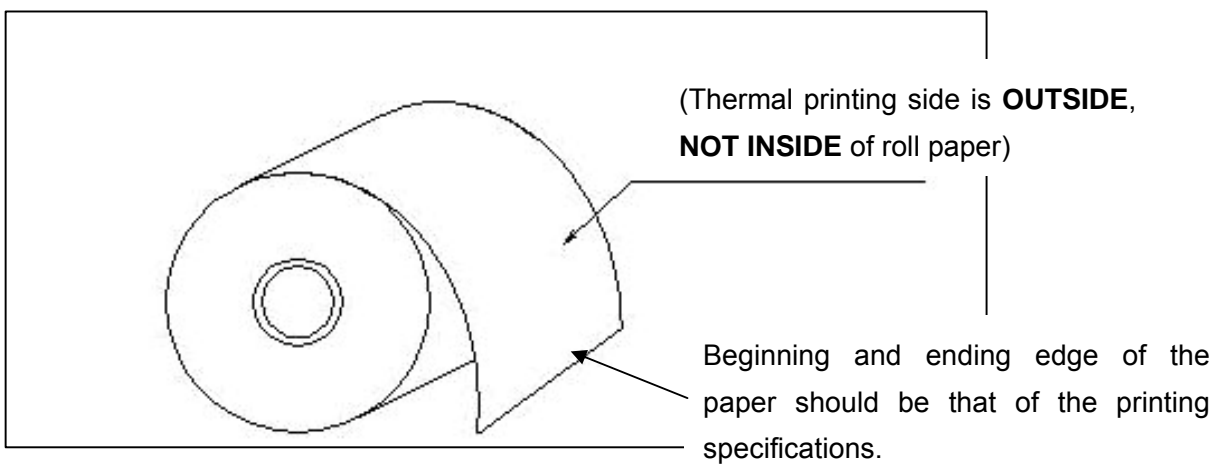

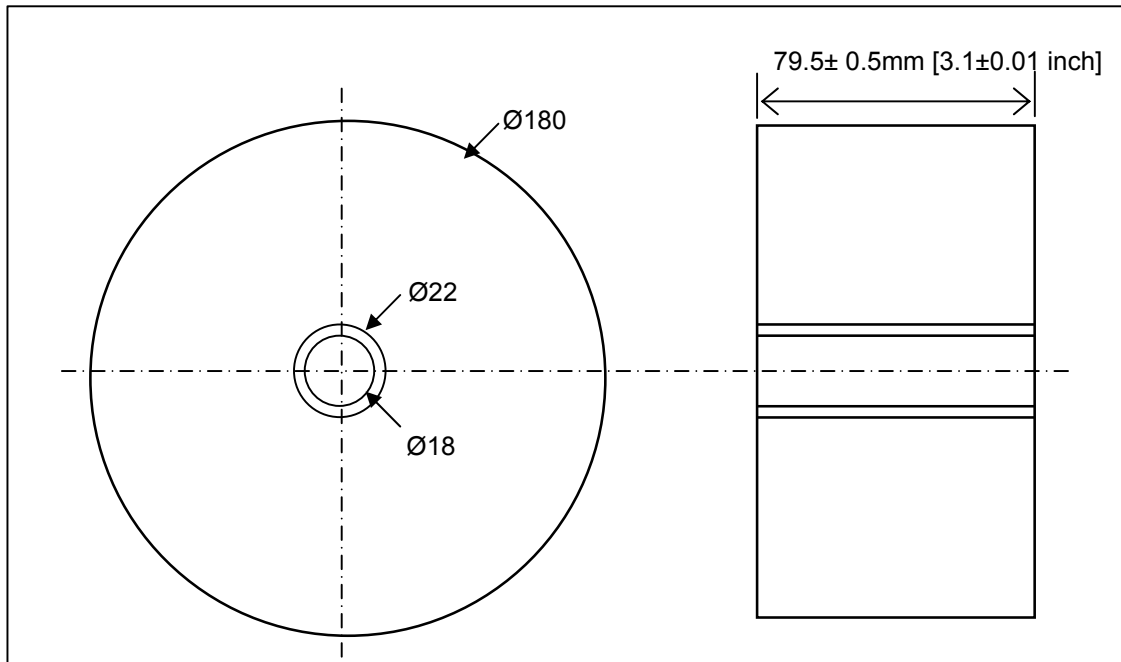

Fig. 4.13 Roll Appearance & Dimension

Paper Handling Precautions

- 1) Store it away from high temperature and humidity:
If the paper is stored in a place where temperature is above 50°C [122°F] or humidity is above 90% RH, the coloring capability may deteriorate or the paper surface may inflate.
- 2) Refrain from exposing to direct sunlight:
The paper surface can be inflated if you expose it to direct sunlight or leave it under the fluorescent lamp for a long time.
- 3) Keep it away from the organic solvents:
Paper color may change if the paper comes in contact with organic solvents or glues containing organic solvent.
- 4) Keep it away from plastics:
If the paper comes in contact with materials containing plastics, its coloring capability may deteriorate or de-coloring of the paper may occur.
- 5) Store the paper roll separately to prevent damage to the paper.
- 6) Do not connect the papers with tape.
- 7) Make sure the paper end is not attached to the paper pipe.

8) Make sure the paper is rolled evenly.

9) Miscellaneous:

If the paper comes in contact with carbon copy paper or if the paper surface is scratched with a metallic object, de-coloring may occur.

4.3.2 How to load the receipt paper

Prior to loading the receipt paper, the following must be kept in mind.

NOTE:

1) Load a paper roll into the unit with the shape of the roll kept intact. (Deformed roll may cause jamming.)

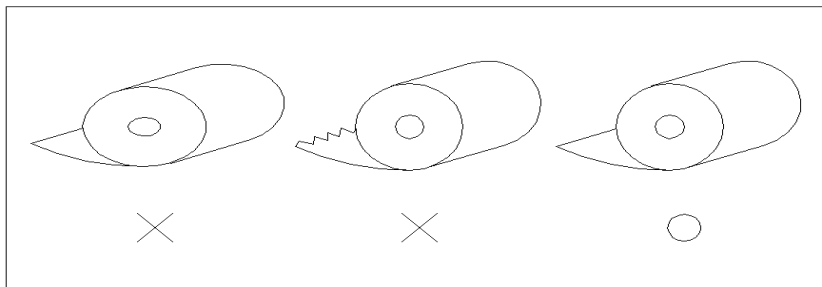

2) The leading edge of the roll shall neatly be cut prior to loading the roll. Correct shape of the paper roll



1) Open the Front Panel with key and pull this outward completely with hands. (Please see the Chapter 4.1.2)

2) Prepare the new paper roll. Please see the NOTE described below

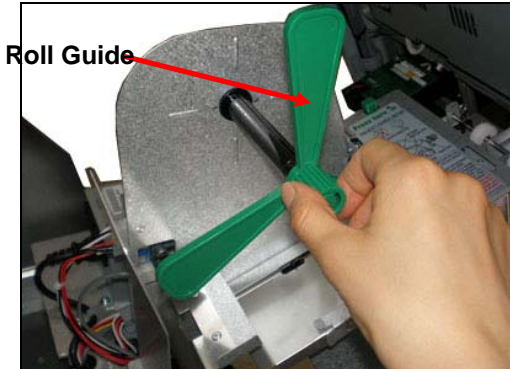

3) Remove the roll guide by carefully pulling it off.

NOTE:

- 1. Make sure the roll is in its proper roll form. (A deformed roll may cause jamming problems)
- 2. When replacing the new roll, make sure the end of the roll paper has a clean cut. (See the below figure.)

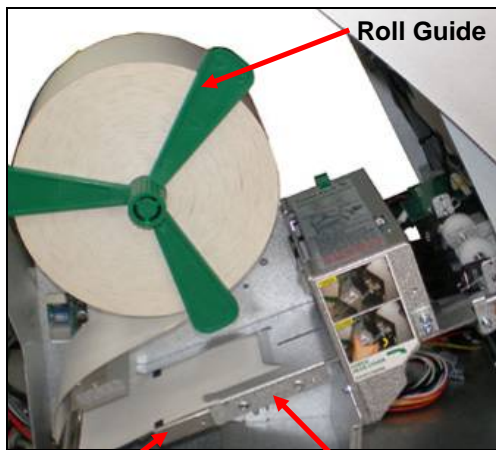
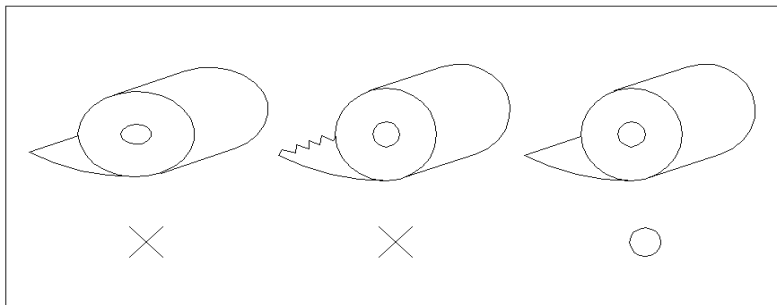

- 4) Add the receipt paper into the rod and then insert the roll guide tightly again to fix it.
- 5) The shiny side of the paper should be faced up to be printed properly and the metallic tension guide should be surrounded with paper to reduce the tension during feeding.
- 6) Insert the leading edge of paper between lower guide and upper guide of the receipt printer slowly. When the machine is initialized, the paper is going to start feeding.

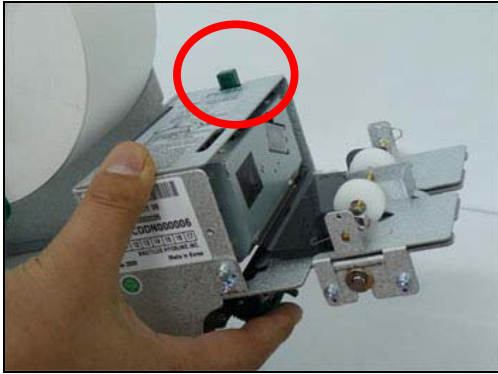

7) If the paper does not feed at all during initializing, make sure that paper has a CLEAN CUT at the end and the Thermal Print Head (TPH) is closed as shown in left picture.



8) When finished loading paper, close the Front Panel and remove the key.

NOTE: THE BASIC MECHANISM OF RECEIPT PRINTER

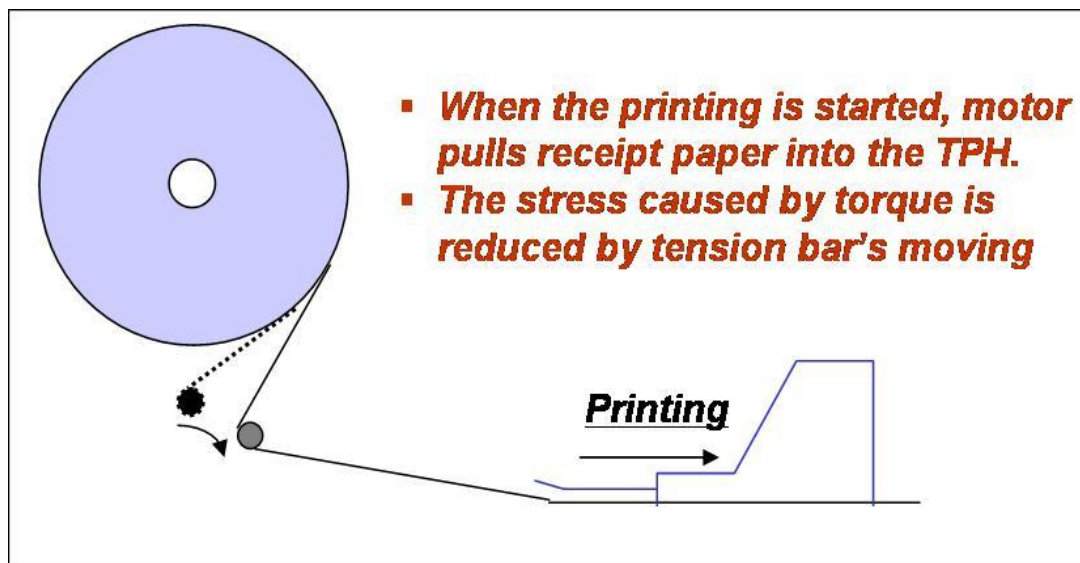
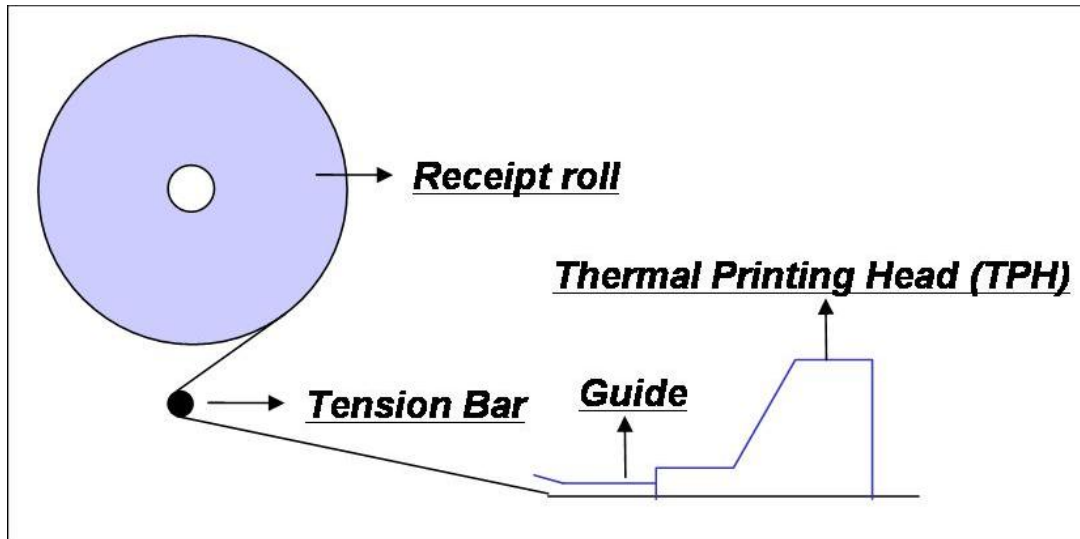

4.3.3 How to Clear a Receipt Jam



1) Open the Front Panel with key and pull this outward completely with hands.

To remove a jammed paper inside transport path, press down the green button to release the lower roller assembly.



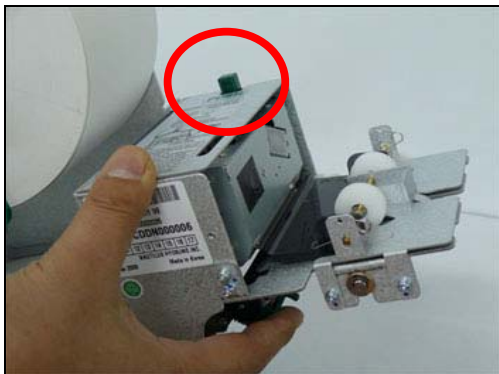

2) To take out a jammed paper in front of transport path, lift up the transparent window guide and remove the jamming receipt carefully.

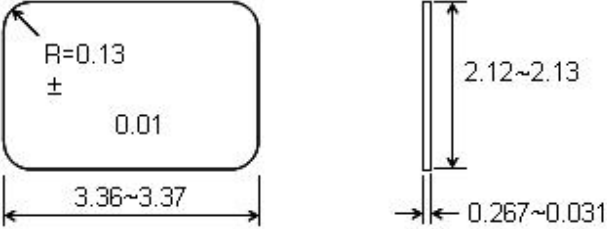

3) After finishing clearing the receipt, load the receipt paper properly. Make sure that the Thermal Print Head (TPH) is closed. When finished loading paper, close the Front Panel and remove the key.

4.4 Magnetic Card Specifications

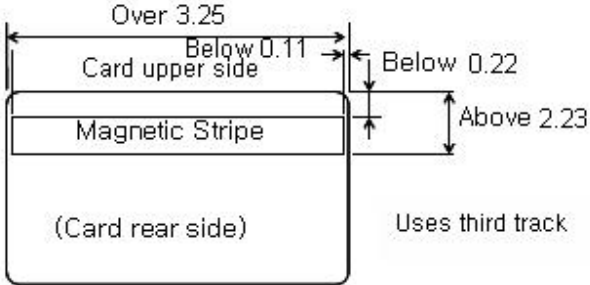
Item	ISO Card (Unit : Inch)
Length	 <p>Diagram showing ISO card dimensions: Length is 2.12~2.13 inches, width is 3.36~3.37 inches. Corner radius is R=0.13 ± 0.01 inches. Thickness is 0.267~0.031 inches.</p>
Card Bending	 <p>Diagram showing card bending specification: Below 0.079 inches.</p>
Magnetic Stripe Position	 <p>Diagram showing magnetic stripe position: Card upper side, Magnetic Stripe, (Card rear side). Dimensions: Over 3.25 inches, Below 0.11 inches, Below 0.22 inches, Above 2.23 inches. Uses third track.</p>

Chapter 5. Operator Function

5.1 BASIC SYSTEM OPERATION

5.1.1 PASSWORD FOR ENTERING SUPERVISOR MODE



- Location of Function Key on ATM -

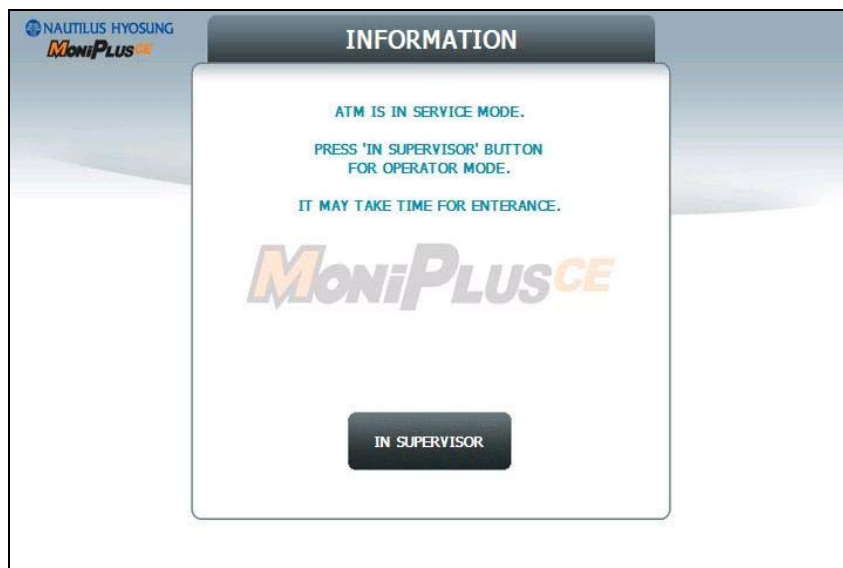

- Main Screen on SPL of Rear Type Machine -

To enter Supervisor mode press the **ENTER, CLEAR, CANCEL, 1, 2 and 3** keys in order.

(In case of **Rear Type Machine**, press the **IN SUPERVISOR** button)

The default password is "555555" (6 digits). The default password is changeable in Supervisor mode.

If the correct password is entered, the OPERATOR FUNCTION menu will be displayed.

Pressing **CLEAR** key erases the entered number and pressing **CANCEL** key goes to in-service-mode. Depending on authority, there are three kinds of default password like below table.

Authority	Default Password
OPERATOR	111111 (6 digits)
SERVICE	222222 (6 digits)
MASTER	555555 (6 digits)

Please make sure that default password should be changed to different password for your security as soon as this machine is installed at field site.

•Authorities for each Mode

No	Working Management Function						CE Authority		
	Main	Sub1	Sub2	Sub3	Sub4	Sub5	M	S	O
1	SETTLEMENT	ADD CASH	1ST CST	-	-		O	O	O
			2ND CST	-	-		O	O	O
			3RD CST	-	-		O	O	O
			4TH CST	-	-		O	O	O
			APPLY	-	-	-	O	O	O
		DAY TOTAL	-	-	-	O	O	O	
		TRIAL DAY TOTAL	-	-	-	O	O	O	
		CASSETTE TOTAL	-	-	-	O	O	O	
2	JOURNAL	CLEAR JOURNAL	-	-	-		O	O	O
		CLEAR TRANS. SEQUENCE NO.	-	-	-		O	O	O
		VIEW JOURNAL	PREV	-	-		O	O	O
			NEXT	-	-		O	O	O
			PREV 50	-	-		O	O	O
			NEXT 50	-	-		O	O	O
			MOVE START	-	-		O	O	O
			MOVE LAST	-	-		O	O	O
			PRINT THIS	-	-		O	O	O
		SEARCH JOURNAL	-	-		O	O	O	
		PRINT JOURNAL	-	-	-	O	O	O	
LAST X PRINT	-	-	-	O	O	O			
3	REPORT	ERROR CODE	PREV	-	-		O	O	O
			NEXT	-	-		O	O	O
			PREV 10	-	-		O	O	O
			NEXT 10	-	-		O	O	O
			MOVE FIRST	-	-		O	O	O

No	Working Management Function						CE Authority			
	Main	Sub1	Sub2	Sub3	Sub4	Sub5	M	S	O	
				MOVE LAST	-	-	-	O	O	O
			PRINT THIS	-	-	-	O	O	O	
			SEARCH ERROR CODE	-	-	-	O	O	O	
		SW VERSION	-	-	-	-	O	O	O	
		PRINT ALL SETUP	-	-	-	-	O	O	O	
		ERROR SUMMARY	PRINT	-	-	-	O	O	O	
			CLEAR	-	-	-	O	O	O	
			PREV	-	-	-	O	O	O	
			NEXT	-	-	-	O	O	O	
		REJECT ANALYSIS	PRINT	-	-	-	O	O	O	
			CLEAR	-	-	-	O	O	O	
4	DIAGNOSTICS	INITIALIZE	-	-	-	-	O	O	X	
		RECEIPT PRINTER	-	-	-	-	O	O	X	
		CASH DISPENSER	-	-	-	-	O	O	X	
		MODEM (DIAL UP)	-	-	-	-	O	O	X	
		TCP/IP (TCP/IP)	-	-	-	-	O	O	X	
		CARD SCAN	-	-	-	-	O	O	X	
		AUXILIARY UNIT	SENSOR	CDU SENSOR	-	-	-	O	O	X
				SPR SENSOR	-	-	-	O	O	X
			FLICKER	ALL FLICKER	-	-	-	O	O	X
				EPP FLICKER	-	-	-	O	O	X
				CDU FLICKER	-	-	-	O	O	X
				SPR FLICKER	-	-	-	O	O	X
				MCU FLICKER	-	-	-	O	O	X
		AGING	-	-	-	-	O	O	X	
5	CUSTOMER SETUP	CHANGE MESSAGE	WELCOM MESSAGE	-	-	-	O	O	O	

No	Working Management Function						CE Authority			
	Main	Sub1	Sub2	Sub3	Sub4	Sub5	M	S	O	
				RECEIPT HEADER	-	-	-	O	O	O
			RECEIPT TAIL	-	-	-	O	O	O	
			RECEIPT ADDRESS & PHONE NUMBER	-	-	-	O	O	O	
		BIN LIST	EXTENDED BIN LIST	PREV	-	-	O	O	X	
					NEXT	-	-	O	O	X
				ADD	-	-	-	O	O	X
				EDIT	-	-	-	O	O	X
				DELETE	-	-	-	O	O	X
				DELETE ALL	-	-	-	O	O	X
		OPTIONAL FUNCTION1	MOD 10 CHECK	EN/DISABLE	-	-	O	O	X	
				BALANCE AT START	EN/DISABLE	-	-	O	O	X
					CONTINUE EN/DISABLE	-	-	O	O	X
				ACCOUNTS	CREDIT CARD EN/DISABLE	-	-	O	O	X
				SELECT RECEIPT	EN/DIABLE	-	-	O	O	X
				PRE-DIALING (DIAL UP)	EN/DISABLE	-	-	O	O	X
					AFTER CARD	-	-	O	O	X
					AFTER PIN	-	-	O	O	X
					AFTER ACCOUNT	-	-	O	O	X
				CHECK CASHING	CERTIFICATION	-	-	O	O	X
					EN/DISABLE	-	-	O	O	X
					MESSAGE TYPE	-	-	O	O	X
			PIN OPTION EN/DISABLE		-	-	O	O	X	
		OPTIONAL FUNCTION2	DEVICE OPTION	RECEIPT PAPER	-	-	O	O	X	
					LOW SENEOR	-	-	O	O	X
					CST SOUND	-	-	O	O	X

No	Working Management Function						CE Authority			
	Main	Sub1	Sub2	Sub3	Sub4	Sub5	M	S	O	
				EPP FLICKER ON	-	-	O	O	X	
		SCREEN SERVICES	CHANGE BACKGROUND	EN/DISABLE		O	O	X		
				DEFAULT SCREEN	SCREEN 1		O	O	X	
					SCREEN 2		O	O	X	
					SCREEN 3		O	O	X	
					SCREEN 4		O	O	X	
					SCREEN 5		O	O	X	
					SCREEN 6		O	O	X	
				SCREEN 1	EN/DISABLE		O	O	X	
					SCREEN 2	EN/DISABLE		O	O	X
					SCREEN 3	EN/DISABLE		O	O	X
					SCREEN 4	EN/DISABLE		O	O	X
					SCREEN 5	EN/DISABLE		O	O	X
					SCREEN 6	EN/DISABLE		O	O	X
				NOTICE (NH2700 Only)	EN/DISABLE		-	O	O	X
		TITLE			-	O	O	X		
		MESSAGE			-	O	O	X		
	SURCHARGE MODE	EN/DISABLE	-	-	-	O	O	X		
		OWNER	-	-	-	O	O	X		
		AMOUNT	-	-	-	O	O	X		
		PERCENT	EN/DISABLE	-	-	-	O	O	X	
			PERCENTAGE	-	-	-	O	O	X	
			WARNING MANNER	-	-	-	O	O	X	
			LOCATION	-	-	-	O	O	X	
	ADVERTISEMENT	COUPON	COUPON TYPE	-	-	O	O	X		
			COUPON SETTING	BASIC COUPON	COUPON1		O	O	X	
		COUPON2				O	O	X		
		COUPON3				O	O	X		
		COUPON4			O	O	X			
	COUPON5		O		O	X				

No	Working Management Function						CE Authority			
	Main	Sub1	Sub2	Sub3	Sub4	Sub5	M	S	O	
						COUPON6	O	O	X	
					ENHANCED COUPON	CUT OPTION	O	O	X	
						COUPON1	O	O	X	
						COUPON2	O	O	X	
						COUPON3	O	O	X	
						COUPON4	O	O	X	
						COUPON5	O	O	X	
						COUPON6	O	O	X	
		WELCOME ADVERTISEMENT		TIMER	-	-	O	O	X	
				SCREEN 1	EN/DISABLE	-	-	O	O	X
					DELETE	-	-	O	O	X
				SCREEN 2	EN/DISABLE	-	-	O	O	X
					DELETE	-	-	O	O	X
				SCREEN 3	EN/DISABLE	-	-	O	O	X
					DELETE	-	-	O	O	X
				SCREEN 4	EN/DISABLE	-	-	O	O	X
					DELETE	-	-	O	O	X
				SCREEN 5	EN/DISABLE	-	-	O	O	X
					DELETE	-	-	O	O	X
				SCREEN 6	EN/DISABLE	-	-	O	O	X
					DELETE	-	-	O	O	X
			TRANSACTION ADVERTISEMENT		TIMER	-	-	O	O	X
				SCREEN 1	EN/DISABLE	-	-	O	O	X
					DELETE	-	-	O	O	X
				SCREEN 2	EN/DISABLE	-	-	O	O	X
					DELETE	-	-	O	O	X
				SCREEN 3	EN/DISABLE	-	-	O	O	X
					DELETE	-	-	O	O	X
				SCREEN 4	EN/DISABLE	-	-	O	O	X
					DELETE	-	-	O	O	X

No	Working Management Function						CE Authority		
	Main	Sub1	Sub2	Sub3	Sub4	Sub5	M	S	O
					SCREEN 5	EN/DISABLE	-	O	O
				SCREEN 5	DELETE	-	O	O	X
				SCREEN 6	EN/DISABLE	-	O	O	X
				SCREEN 6	DELETE	-	O	O	X
		STANDARD3 OPTION	STATUS MONITORING EN/DISABLE	-	-	-	O	X	X
			COMMUNICATION HEADER	-	-	-	O	X	X
			COMMUNICATION ID	-	-	-	O	X	X
			CRC EN/DISABLE	-	-	-	O	X	X
		STANDARD1 OPTION	TERMINAL STATUS EN/DISABLE				O	X	X
			HOST ERROR EN/DISABLE				O	X	X
			REVERSAL REASON EN/DISABLE				O	X	X
		SELECT PROCESSOR	COMMUNICATION	DIALUP	-	-	O	X	X
				TCP/IP	-	-	O	X	X
			EOT/ENQ OPTION	GENERAL	-	-	O	X	X
				EOT OPTIONAL	-	-	O	X	X
				NO EOT REQUIRED	-	-	O	X	X
				NO ENQ REQUIRED	-	-	O	X	X
				MESSAGE FORMAT	STANDARD 1	-	-	O	X
				STANDARD 2	-	-	O	X	X
				STANDARD 3	-	-	O	X	X

No	Working Management Function						CE Authority			
	Main	Sub1	Sub2	Sub3	Sub4	Sub5	M	S	O	
				EPS	-	-		O	X	X
		TCP/IP TYPE	VISA FRAMED	-	-		O	X	X	
			STANDARD	-	-		O	X	X	
			ACK CONTROLLED	-	-		O	X	X	
			SSL EN/DISABLE	-	-		O	X	X	
			REVERSAL RETRY COUNT	-	-	-		O	X	X
6	SYSTEM SETUP	DATE & TIME	YEAR	-	-	-		O	O	O
			MONTH	-	-	-		O	O	O
			DAY	-	-	-		O	O	O
			HOUR	-	-	-		O	O	O
			MINUTE	-	-	-		O	O	O
			APPLY	-	-	-		O	O	O
		SPEAKER VOLUME	UP	-	-	-		O	O	O
			DOWN	-	-	-		O	O	O
		TERMINAL IP (TCP/IP)	IP ADDRESS	-	-	-		O	O	X
			SUBNET MASK	-	-	-		O	O	X
			GATEWAY	-	-	-		O	O	X
			DNS	-	-	-		O	O	X
			DHCP EN/DISABLE	-	-	-		O	O	X
		LANGUAGE EN/DISABLE	DEFAULT LANGUAGE	-	-	-		O	O	O
			ENGLISH EN/DISABLE	-	-	-		O	O	O
			SPANISH EN/DISABLE	-	-	-		O	O	O
			FRENCH EN/DISABLE	-	-	-		O	O	O

No	Working Management Function						CE Authority		
	Main	Sub1	Sub2	Sub3	Sub4	Sub5	M	S	O
			OPERATOR PASSWORD	-	-	-	O	O	O
	CHANGE PASSWORD	SERVICE PASSWORD	-	-	-	O	O	X	
		MASTER PASSWORD	-	-	-	O	X	X	
	MODEM PARAMETERS (DIAL UP)	HOST INITIAL STRING	-	-	-	O	O	X	
		RMS INITIAL STRING	-	-	-	O	O	X	
		MODEM TEST	-	-	-	O	O	X	
	DEVICE SETUP	CDU SETUP	COUNTRY	-	-	O	O	X	
			CDU TYPE	-	-	O	O	X	
			CASSETTE VOLUME	-	-	O	O	X	
			EXECUTE	-	-	O	O	X	
		CALRIBRATION (Rear Type Only)				O	O	X	
		TOUCH VIBRATION (Touch Type Only)	EN/DISABLE			O	O	X	
	SYSTEM CONTROL	SOFTWARE UPDATE	-	-	-	O	O	O	
		REBOOT	-	-	-	O	O	O	
		BACKUP ALL JOURNAL TO USB	-	-	-	O	O	O	
		BACKUP JOURNAL BY DATE TO USB	FROM	-	-	O	O	O	
			TO	-	-	O	O	O	
		SEARCH	-	-	-	O	O	O	
		BACKUP LOG TO USB	-	-	-	O	O	O	

No	Working Management Function						CE Authority			
	Main	Sub1	Sub2	Sub3	Sub4	Sub5	M	S	O	
				CLEAR NVRAM	CLEAR ALL	-	-	O	X	X
				CLEAR SETTING	-	-	O	X	X	
				CLEAR JOURNAL	-	-	O	X	X	
				CLEAR TRANS SEQUENCE NUMBER	-	-	O	X	X	
				CLEAR LOG	-	-	O	X	X	
			BACK NVRAM				O	X	X	
			RESTORE NVRAM				O	X	X	
7	HOST SETUP	KEY MANAGEMENT	KEY MODE	-	-	-	O	X	X	
			KEY INDEX	-	-	-	O	X	X	
			CHECK KEY	-	-	-	O	X	X	
			EDIT KEY	MASTER KEY PART A	-	-	-	O	X	X
				MASTER KEY PART B	-	-	-	O	X	X
				UNIQUE KEY PART A	-	-	-	O	X	X
				UNIQUE KEY PART B	-	-	-	O	X	X
				MAC KEY PART A	-	-	-	O	X	X
				MAC KEY PART B	-	-	-	O	X	X
				MAC KEY PART A	-	-	-	O	X	X
			SERIAL NUMBER	-	-	-	O	X	X	
			TELEPHONE NUMBER (DIAL UP)	HOST PHONE 1	-	-	-	O	X	X
				HOST PHONE 2	-	-	-	O	X	X
			HOST ADDRESS (TCP/IP)	URL EN/DISABLE	-	-	-	O	X	X
				HOST ADDRESS 1	-	-	-	O	X	X
				PORT NUMBER 1	-	-	-	O	X	X
				HOST ADDRESS 2	-	-	-	O	X	X
PORT NUMBER 2	-	-		-	O	X	X			

No	Working Management Function						CE Authority		
	Main	Sub1	Sub2	Sub3	Sub4	Sub5	M	S	O
			TERMINAL ID	-	-	-	-	O	X
		HEALTH CHECK	EN/DISABLE	-	-	-	O	O	X
		MESSAGE	SEND INTERVAL	-	-	-	O	O	X
		REMOTE MONITOR	RMS EN/DISABLE	EN/DISABLE	-	-	O	O	X
				RMS RING COUNT (DIAL UP)	-	-	O	O	X
				ATM LISTENING PORT (TCP/IP)	-	-	O	O	X
			RMS Status Send En/Disable	EN/DISABLE-	-	-	O	O	X
				URL En/Disable (TCP/IP)	-	-	O	O	X
				PHONE NUMBER1 (DIAL UP)	-	-	O	O	X
				PHONE NUMBER2 (DIAL UP)	-	-	O	O	X
				INTERVAL	-	-	O	O	X
				RMS ADDRESS (TCP/IP)	-	-	O	O	X
				RMS LISTENING PORT (TCP/IP)	-	-	O	O	X
		RMS PASSWORD	-	-	-	O	O	X	
		ROUTING ID	-	-	-	-	O	X	X
		AUTO DAY TOTAL	EN/DISABLE	-	-	-	O	O	O
			TOTAL TYPE	-	-	-	O	O	O
			HOUR	-	-	-	O	O	O
			MINUTE	-	-	-	O	O	O
8	TRANSACTION SETUP	DISPENSE LIMIT	-	-	-	-	O	O	X
		FAST CASH	LB 0	-	-	-	O	O	X
			LB 1	-	-	-	-	O	O

No	Working Management Function						CE Authority		
	Main	Sub1	Sub2	Sub3	Sub4	Sub5	M	S	O
				LB 2	-	-	-	O	O
			RB 0	-	-	-	O	O	X
			RB 1	-	-	-	O	O	X
			RB 2	-	-	-	O	O	X
		LOW CURRENCY CHECK EN/DISABLE	-	-	-	-	O	O	X
		DENOMINATION	1ST CASSETTE	-	-	-	O	X	X
			2ND CASSETTE	-	-	-	O	X	X
			3RD CASSETTE	-	-	-	O	X	X
			4TH CASSETTE	-	-	-	O	X	X
9	IN SERVICE	-	-	-	-	-	O	O	O
10	SITE MAP	-	-	-	-	-	O	O	O
11	QUICK REPLENISH	-	-	-	-	-	O	O	O
12	QUICK CONFIGURATION	-	-	-	-	-	O	X	X

5.1.2 When an Error Occurs

When you try to enter Supervisor Mode or go into **IN SERVICE MODE** from supervisor menu, the screen below will be displayed if there is any ERROR.

Press **DEVICE INITIALIZE** button, if the error is caused by a device so it can be cleared by initializing. Press **OPERATOR FUNCTION** button, if you have to set up any information to clear the error. And set up the information which is missed.

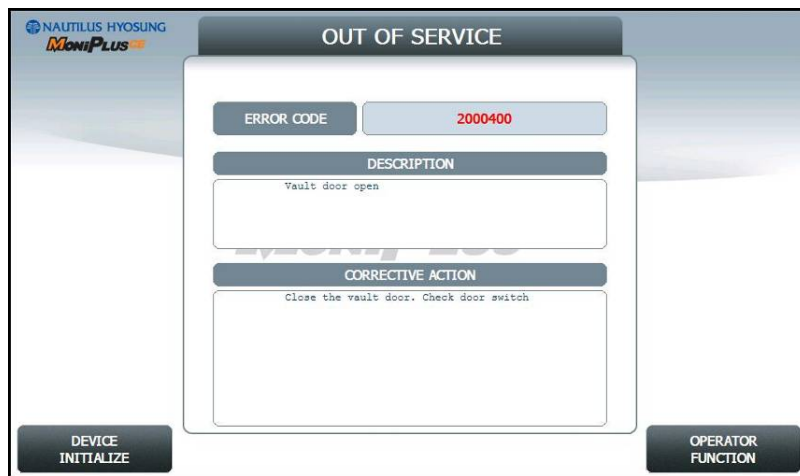

NOTE: If the machine goes out of service, the error code will not always appear on the screen. If you do not see an error code, enter operator function and go to reports. Look in the error summary for error codes.

5.1.3 How to Use Keypad (Function Key Type)

This section explains the basic operation of the Keypad.

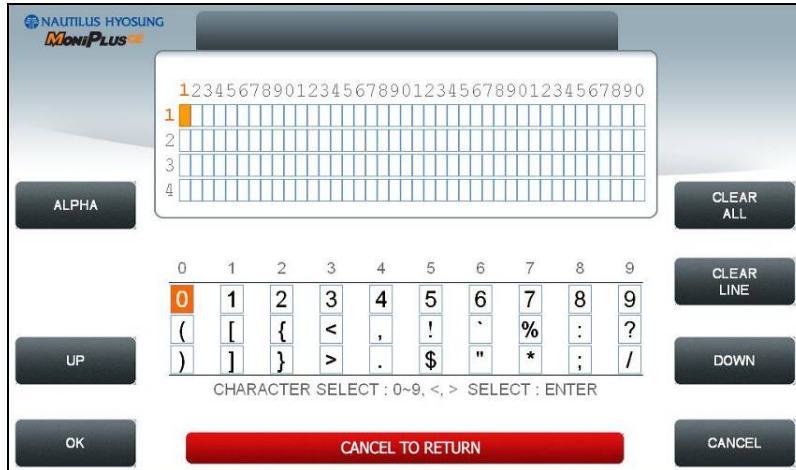

[Default Keypad Character Table Screen]

Shift Status			0	1	2	3	4	5	6	7	8	9	
F1	NUMBER	-	0	1	2	3	4	5	6	7	8	9	
	ALPHA	F3	UPPER	([{	<	,	!	'	%	:	?
)]	}	>	.	\$	"	*	;	/
			LOWER	+ Space	A	D	G	J	M	P	T	W	
		=	Q	B	E	H	K	N	R	U	X		
			=	Z	C	F	I	L	O	S	V	Y	
	TABLE	-	The character on the current cursor position on the screen will be selected										

How to Enter the Character

- A. The Keypad Character Table will appear on the bottom of the screen in all keypad input screens.
- B. F1 key gives the option for ALPHA or NUMBER, Table mode. Default is NUMBER.
- C. F3 key gives the option for Upper or Lowercase characters. It is valid only in the ALPHA mode. Default is Uppercase.
- D. The input of characters is limited to the space provided.
- E. Key can be changed whenever you press it to choose proper character. For example, when key "1" is pressed once it is "SPACE", pressed twice it is "Q", pressed third time it is "Z" in case of the Alpha mode. When the desired character is selected, press ENTER.
- F. ◀, ▶ keys move the cursor position in the ALPHA or NUMBER mode. In the TABLE mode ◀, ▶ keys are used to select the character.
- G. **F2** key is used to clear the whole screen and returns the cursor to its initial position.
- H. **F4** key and **CLEAR** key in pinpad is used to clear the current line.
- I. **F5** key is used to save the current changes.
- J. **F6** key and **CANCEL** key in pinpad are used to exit. (If you didn't press F5 key after changing, the changes will be ignored.)
- K. **F7** key is used to move the cursor position **UP**.
- L. **F8** key is used to move the cursor position **DOWN**.

5.1.4 How to Use Keypad (Touch Screen Type)

You can use this Keypad in same way as a computer keyboard.

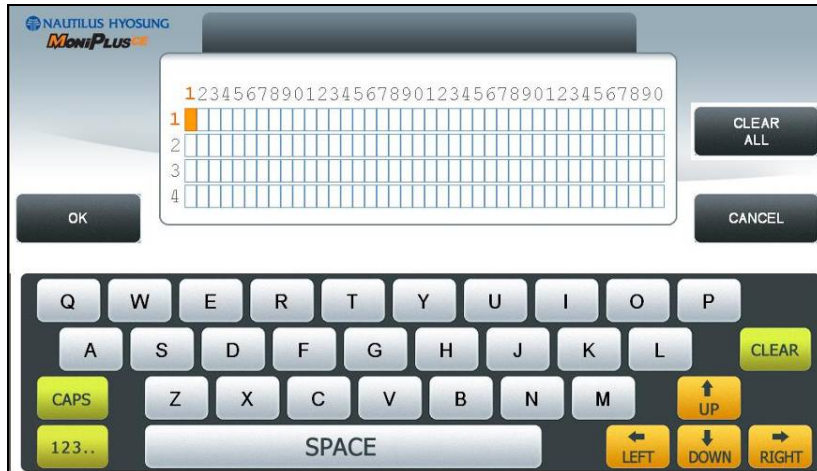

[Default Keypad Character Table Screen]

Key	Character Table
ABC..	Q W E R T Y U I O P A S D F G H J K L Z X C V B N M
CAPS	q w e r t y u i o p a s d f g h j k l z x c v b n m
123	1 2 3 4 5 6 7 8 9 0 ~ ! @ # \$ % ^ & * + - : ; < > ?
+ /	1 2 3 4 5 6 7 8 9 0 () { } [] _ = " ' , . / \ £

5.2 SUPERVISOR MENU

The following screen below is the main screen of Supervisor mode.

Supervisor mode in this machine is largely composed of ATM Status and Function.

A. ATM Status

- 1) Machine Kind and Country Code
- 2) Program version
- 3) Serial Number
- 4) Line Type (Dial-up, TCP/IP)
- 5) Message Format
- 6) Terminal ID
- 7) The Media Status of 1st Cassette
- 8) The Media Status of 2nd Cassette
- 9) The Media Status of 3rd Cassette
- 10) The Media Status of 4th Cassette
- 11) 1st Cassette: Remaining notes (Denomination)
e.g) if 1000 notes of \$20, 1000(\$20)
- 12) 2nd Cassette: Remaining notes (Denomination)
- 13) 3rd Cassette: Remaining notes (Denomination)
- 14) 4th Cassette: Remaining notes (Denomination)
- 15) Reject Box Status (Rejected Count)
- 16) Error Code
- 17) The Status of Card
- 18) The Status of Pinpad
- 19) The Status of Cash Dispenser
- 20) The Status of Receipt Printer
- 21) Current Date and Time
- 22) Last Transaction Time
- 23) Operator User

B. Functions

- 1) IN SERVICE
- 2) SITE MAP
- 3) QUICK REPLENISH
- 4) QUICK CONFIGURATION
- F1) SETTLEMENT
- F2) CUSTOMER SETUP
- F3) JOURNAL
- F4) SYSTEM SETUP
- F5) REPORT
- F6) HOST SETUP
- F7) DIAGNOSTICS
- F8) TRANSACTION SETUP

In order to move to the in-service mode, press the **1** or **CANCEL** key in pinpad.

In order to reset terminal error, press the **CLEAR** key in pinpad.



[Function Key Type]



[Touch Type]

C. Field Values

CLASS	VALUE (eg.)	Remarks
MACHINE KIND	NH-2700 /NH-2700 L / NH-1800SE	
COUNTRY CODE	USA, Canada, Mexico, Australia, New Zealand	
PROGRAM VERSION	V06.00.05	
LINE TYPE	TCP/IP DIAL-UP	
MESSAGE FORMAT	STANDARD1 STANDARD2 STANDARD3 EPS	
TERMINAL ID	NH2700 / NH1800SE	
ERROR CODE	[00000(00)]	
STATUS		
CST1(Remaining Notes)	BILLS COUNT - 1047(\$10) N/A	
CST2(Remaining Notes)	BILLS COUNT - 18(\$20) N/A	
CST3(Remaining Notes)	BILLS COUNT - 20(\$50) N/A	
CST4(Remaining Notes)	N/A	Not Available
CST1(Media Status)	MISSING NORMAL LOW EMPTY FULL	
CST2(Media Status)	MISSING NORMAL LOW EMPTY FULL	

CST3(Media Status)	MISSING NORMAL LOW EMPTY FULL	
CST4(Media Status)	N/A	
REJECT	REJECT COUNT(CDU) – (0)	
Card	OK ERROR	
Pinpad	OK ERROR	
Cash Dispenser	OK ERROR	
Receipt Printer	OK ERRPR	

5.3 SETTLEMENT

This menu contains **ADD CASH**, **DAY TOTAL**, **TRIAL DAY TOTAL**, **CASSETTE TOTAL** and **TRIAL CASSETTE TOTAL**. Please press each button on this menu to go to next screen or to operate the related function. To go back to the previous screen, press the **CANCEL** key in pinpad.



- 1) **ADD CASH**: Go to the next screen
- 2) **DAY TOTAL**: Do settlement with host. After settlement, clear transaction information.
- 3) **TRIAL DAY TOTAL**: Just do settlement with host. (Not clear transaction info.)
- 4) **CASSETTE TOTAL**: Show note count and then clear note count.
- 5) **TRIAL CASSETTE TOTAL**: Just show note count. (Not clear note count.)

5.3.1 ADD CASH

By pressing button on this menu, you can select cassette to add note count. (Cassette numbers are designated from top to bottom). Input the note count you want to add and press the **ENTER** key in the pinpad. If you completed the all cassettes, you have to press **APPLY** button to effect the value changes.

NOTE: The total note count you enter must not exceed the maximum note count.
(Max. note count: 2,000/CST)

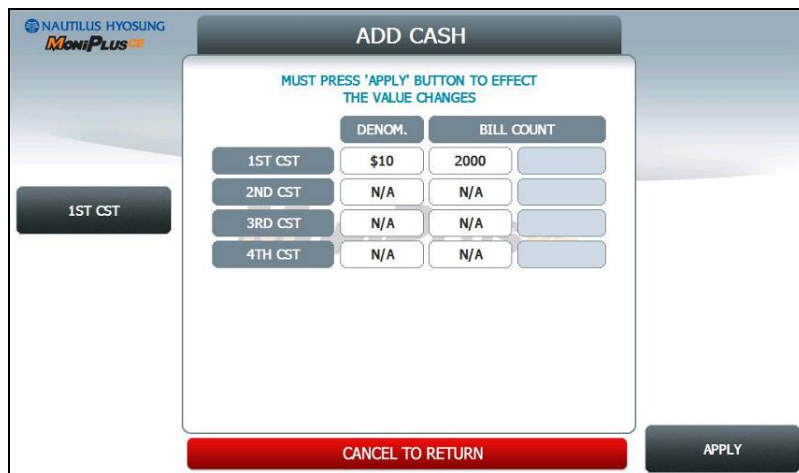

5.4 JOURNAL

This **JOURNAL** menu contains **CLEAR JOURNAL**, **CLEAR TRANS. SEQUENCE NO.**, **VIEW JOURNAL**, **PRINT JOURNAL**, and **PRINT LAST X** sub menu.



- 1) **CLEAR JOURNAL**: The **CLEAR JOURNAL** function is used to delete all journal data
- 2) **CLEAR TRANS. SEQUENCE NO**: This function will reset the journal sequence number to <0000>. This may be useful if you switch processing or switch Terminal ID numbers and want to keep new records.
- 3) **PRINT JOURNAL**: The **PRINT JOURNAL** function is used to print out all the journals which have not been printed from the last printed journal. If you want to stop printing, you may stop it by pressing **CANCEL** key.
- 4) **VIEW JOURNAL** : Go to the next screen
- 5) **PRINT LAST X**: Go to the next screen

5.4.1 VIEW JOURNAL

You can see the various kinds of journal data by using each field and button. The VIEW function is used to display the Journal data on the customer screen. The Journal record will be displayed on the screen.



Use **PREV** or **NEXT** button to show just one data before or after, and **PREV 50** or **NEXT 50** buttons are for data before 50 or after 50 EA. If you use **MOVE FIRST** or **MOVE LAST** button, you can see first or last journal. Besides, you can check up journal data you would try to search by using **SEARCH JOURNAL** button and just print out the current journal by pressing **PRINT THIS** button.

5.4.1.1 SEARCH JOURNAL

You can search a specific journal with a journal index and see it if the index is valid.



5.4.2 PRINT LAST X

The **PRINT LAST X** function is used to print out recent journal data. If you want to print recent journal data, enter the count of data you want on JOURNAL main screen and then press **ENTER** key. Then the data you request is printed.

If you want to stop printing, you may stop by pressing **CANCEL** key.



5.5 REPORT

This report menu consists of 5 sub-menus. **ERROR CODE**, **ERROR SUMMARY**, **SW VERSION**, **PRINT ALL SETUP** and **REJECT ANALYSIS**. You can print out all information regarding each device as well as system value set up. If you want to go back the previous screen, press the **CANCEL** key.



5.5.1 ERROR CODE

ERROR CODE offers detailed descriptions of error codes and way to deal with the errors on a working ATM.

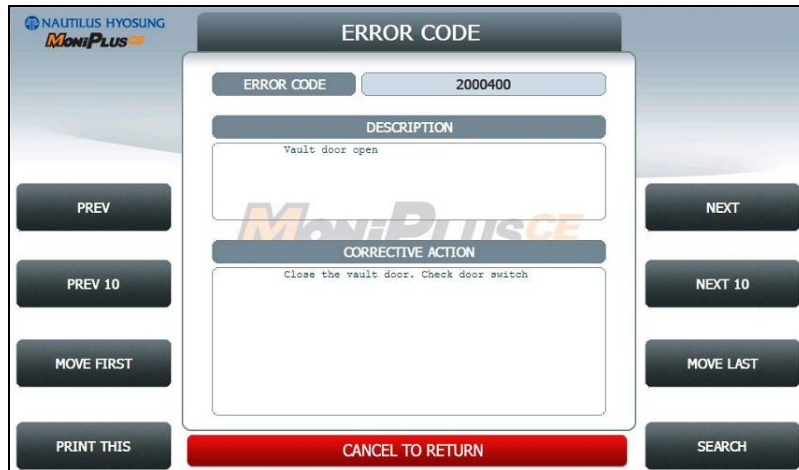

PREV/NEXT buttons are to navigate previous and next error codes one by one and **PREV 10/NEXT 10** are to do by 10 EA... **MOVE FIRST/MOVE LAST** buttons are to go to the first error code and the last one. **PRINT THIS** button is for printing information about the error code displaying in the screen. **SEARCH ERROR CODE** button is to search for a specific error code immediately.

5.5.1.1 SEARCH ERROR CODE

You can search a specific error code if that exists. In order to use the function, please input the specific error code in the field and select **OK** button. If there is no result in database, “**INVALID ERROR CODE**” displays.

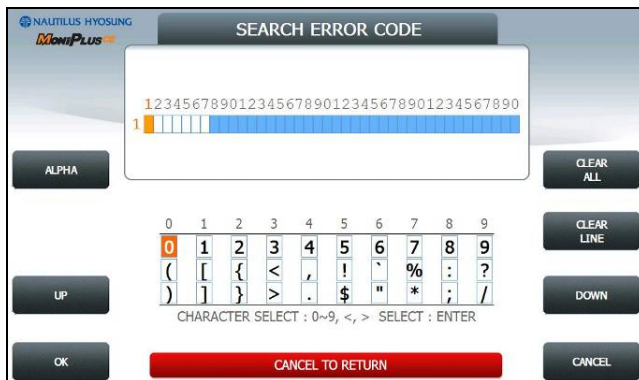

[Function Key Type]



[Touch Type]

5.5.2 SW VERSION

This menu shows each software version. Each version will be displayed. (APPLICATION, CDU EP, CDU SP, SPR EP, SPR SP, MCU EP, MCU SP and etc.)

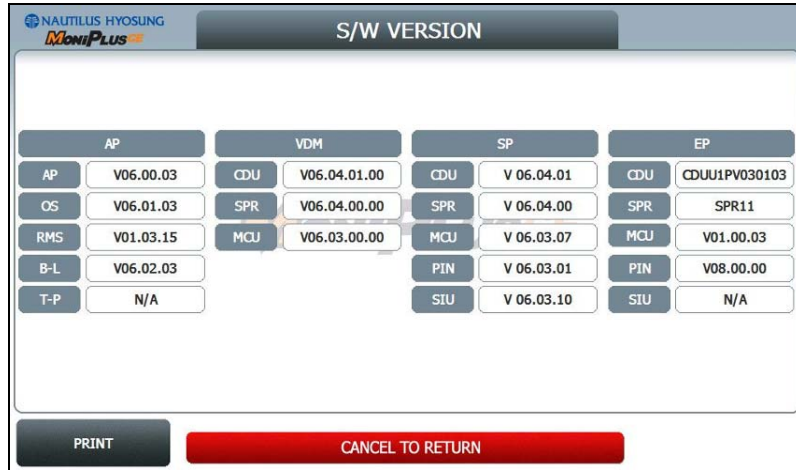

5.5.3 PRINT ALL SETUP List

[DIAL – UP]

NO	ITEM	DESCRIPTION	REMARKS
1	DATE	CURRENT DATE & TIME	
2	MACHINE KIND	NH-2700/ NH-2700 L/NH-2700 T/NH-1800SE	
3	COUNTRY	USA	
4	HOST PROCESSOR	HOST PROTOCOL TYPE	
5	NETWORK TYPE	DIAL-UP	
6	VISA FRAMED OPTION	EOT/ENQ OPTION	
7	VERSION INFORMATION	AP / SP / EP VERSION	
8	SYSTEM SETUP	CURRENT CASSETTE REJECT	
		CURRENT BILLS	
		SERIAL NUMBER	
		SPEAKER VOLUME	
		HOST MODEM INITIAL STRING	
		RMS MODEM INITIALI STRING	
		LANGUAGE MODE	
9	CUSTOMER SETUP	WELCOME MESSAGE INFO	
		RECEIPT HEADER & TAIL INFO	
		RECEIPT ADDRESS & PHONE INFO	
		OPTIONAL FUNCTION 1 INFO	
		OPTIONAL FUNCTION 2 INFO	
		BIN LIST	
		ADVERTISEMENT #n INFO	
10	TRANSACTION SETUP	DISPENSE LIMIT	
		CURRENCY ID	
		DENOMINATION	
		FAST CASH	
		LOW CURRENCY CHECK	
11	HOST SETUP	TERMINAL ID	
		STANDARD 3 OPTION	
		ROUTING ID	
		HOST PHONE NUMBER	
		HEALTH CHECK OPTION	
		AUTO DAY TOTAL OPTION	
		RMS OPTION	
		MASTER KEY INFO	

[TCP / IP]

NO	ITEM	DESCRIPTION	REMARKS
1	DATE	CURRENT DATE & TIME	
2	MACHINE KIND	NH-2700/ NH-2700 L/NH-2700 T	
3	COUNTRY	USA	
4	HOST PROCESSOR	HOST PROTOCOL TYPE	
5	NETWORK TYPE	TCP/IP	
6	TCP/IP TYPE	TCP/IP TYPE	
7	SSL MODE	SSL OPTION	
8	VERSION INFORMATION	AP / SP / EP VERSION	
9	SYSTEM SETUP	CURRENT CASSETTE REJECT	
		CURRENT BILLS	
		SERIAL NUMBER	
		SPEAKER VOLUME	
		ATM IP OPTION	
		LANGUAGE MODE	
10	CUSTOMER SETUP	WELCOME MESSAGE INFO	
		RECEIPT HEADER & TAIL INFO	
		RECEIPT ADDRESS & PHONE INFO	
		OPTIONAL FUNCTION 1 INFO	
		OPTIONAL FUNCTION 2 INFO	
		BIN LIST	
		ADVERTISEMENT #n INFO	
		COUPON #n INFO	
11	TRANSACTION SETUP	DISPENSE LIMIT	
		CURRENCY ID	
		DENOMINATION	
		FAST CASH	
		LOW CURRENCY CHECK	
12	HOST SETUP	TERMINAL ID	
		STANDARD 3 OPTION	
		ROUTING ID	
		HOST ADDRESS INFO	
		HEALTH CHECK OPTION	
		AUTO DAY TOTAL OPTION	
		RMS OPTION	
		MASTER KEY INFO	

5.5.4 ERROR SUMMARY

ERROR SUMMARY menu offers a statistics of error codes on an ATM. It lists the errors by the number of times they occurred. You can print these errors.

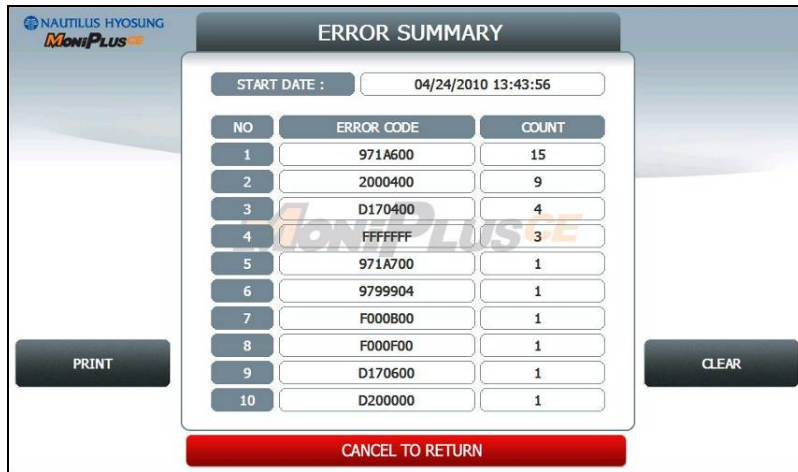

PREV/NEXT buttons are to navigate previous and next pages and **PRINT** button prints all of error code history.

CLEAR button erases the history stacked in an ATM and set **START DATE** to the present date as well. (START DATE displays "01/01/2000 00:00:00" in ATMs which have never done the CLEAR function.)

5.5.5 REJECT ANALYSIS

REJECT ANALYSIS menu offers a statistics of note reject on an ATM. It lists the rejects by the number of times or note counts they occurred. You can print these rejects.

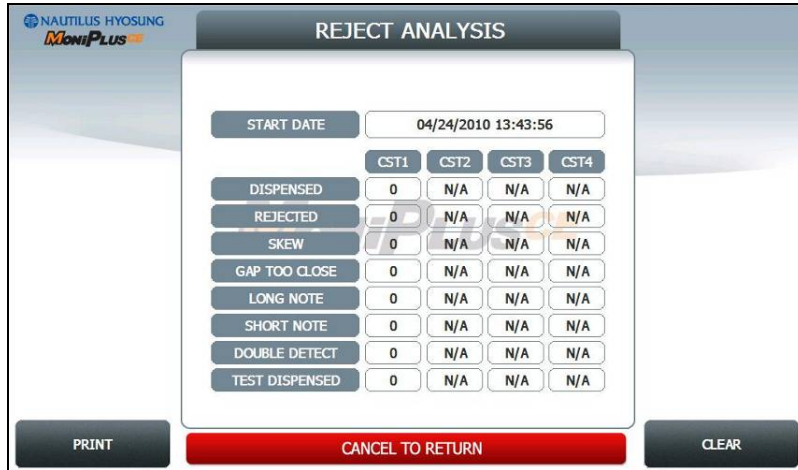

PRINT button prints the reject analysis information.

CLEAR button erases the reject analysis information and set **START DATE** to the present date as well. (START DATE displays "01/01/2000 00:00:00" in ATMs which have never done the CLEAR function.)

5.6 DIAGNOSTICS

This report menu consists of 7 sub-menus. **INITIALIZE**, **RECEIPT PRINTER**, **CASH DISPENSER**, **MODEM (or TCP/IP)**, **CARD SCAN**, **AUXILIARY UNIT** and **AGING**. Please press each button on this menu to go to next screen or to operate the related function. To go back to the previous screen, press the **CANCEL** key in pinpad.

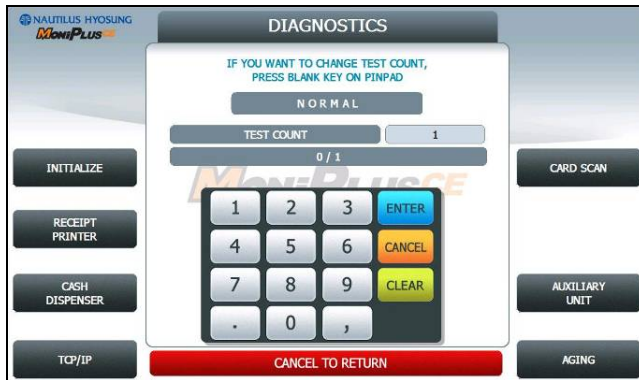

[Function Key Type]



[Touch Type]

Changing the TEST COUNT

The **TEST COUNT** means the number of test.

If you want to change the test count, press **BLANK** key or **SET** button then input the test count and press **ENTER** key. To delete the test count while inputting, press **CLEAR** key. To cancel the test while testing, press **CANCEL** key.

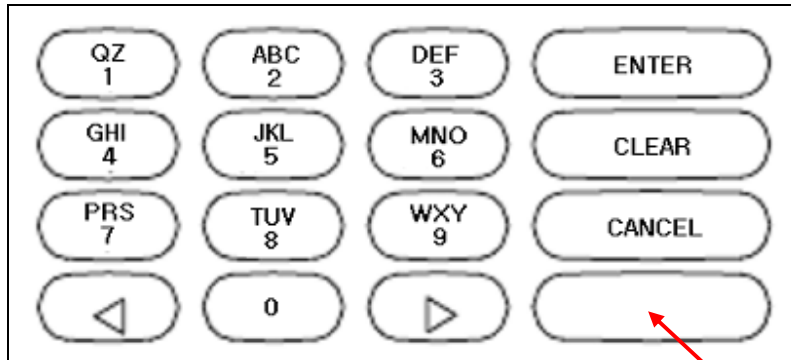

BLANK Key

NOTE: TEST COUNT affects when testing **RECEIPT PRINTER, CASH DISPENSER, and MODEM.**

CASE:

- 1) If you input test count '0', the test count will be "UNLIMIT"
- 2) If you input test count 10, the test will perform 10 times.
- 3) If you cancel a test and then perform same test, the test count will be continue.
 e.g. If you cancel a test when the tested count is 3, and then perform same test, the tested count starts at 3.
- 4) If you cancel a test and then perform another test, the test count will be initialized.
 e.g. If you cancel a test when the tested count is 3, and then perform another test, the tested count starts at 0.

5.6.1 INITIALIZE

The **INITIALIZE** has the function of resetting each unit of this ATM. If an error occurs while executing, the system will stop and display an error code. Confirm the detailed error description in the ERROR CODE of REPORT MENU.

Accessing the INITIALIZE

- 1) Select **DIAGNOSTICS** in the OPERATOR FUNCTION
- 2) Select the **INITIALIZE** in the DIAGNOSTICS menu. All units will be initialized.
- 3) When ATM is in the normal state, the SUCCESS message will be displayed.

5.6.2 RECEIPT PRINTER

The **RECEIPT PRINTER** has the function of printing a sample receipt and cutting out one receipt. If an error occurs while executing, the system will stop and display an error code. Confirm the detailed error description in the ERROR CODE of REPORT MENU.

Accessing the RECEIPT PRINTER

- 1) Select **DIAGNOSTICS** in the OPERATOR FUNCTION.
- 2) Select the **RECEIPT PRINTER** in the DIAGNOSTICS menu. Test String will be printed from the receipt printer.
- 3) When ATM is in the normal state, the SUCCESS message will be displayed.

5.6.3 CASH DISPENSER

The **CASH DISPENSER** has the function of testing the dispense mechanisms. This function will dispense one note from the cassette and dump into the reject bin. If an error occurs, the system will stop and display an error code. Confirm the detailed error description in the ERROR CODE of REPORT MENU

Accessing the CASH DISPENSER

- 1) Select **DIAGNOSTICS** in the OPERATOR FUNCTION.
- 2) Select the **CASH DISPENSER** in the DIAGNOSTICS menu. The **CASH DISPENSER** test will be performed.
- 3) When ATM is normal state, the SUCCESS message will be displayed.

5.6.4 MODEM

The **MODEM** has the function of testing the modem for any errors. Input the desired PHONE NUMBER, and then press **ENTER** Key for TEST DIAL. This function is used to check the function of the modem dial.

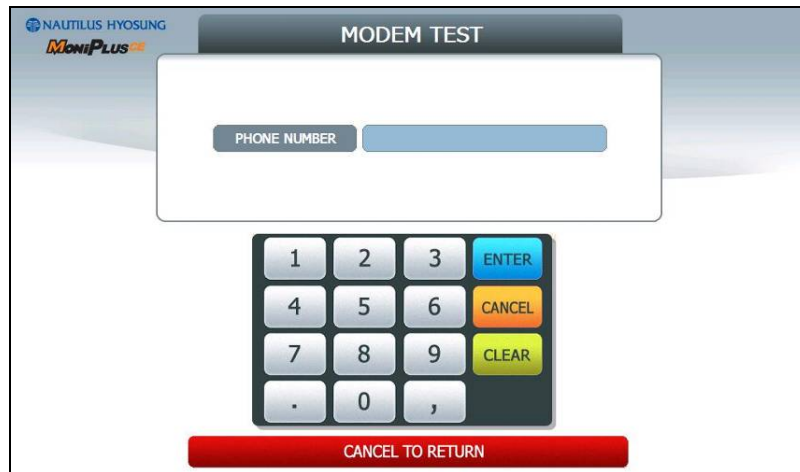

Accessing the MODEM

- 1) Select **DIAGNOSTICS** in the OPERATOR FUNCTION.
- 2) Select the **MODEM** in the DIAGNOSTICS menu.
- 3) The MODEM TEST will be displayed.

5.6.4.1 TCP/IP

The **TCP/IP** has the function of testing the TCP/IP for any errors. Input the desired HOST ADDRESS, HOST PORT, SSL OPTION and SSL VERSION, and then select **CONNECT** for line test. This function is used to check the function of the TCP/IP.



Accessing the TCP/IP

- 1) Select **DIAGNOSTICS** in the OPERATOR FUNCTION.
- 2) Select the **TCP/IP** in the DIAGNOSTICS menu.
- 3) The TCP/IP menu will be displayed.

5.6.5 CARD SCAN

The **CARD SCAN** has the function of testing the magnetic stripe reader and the card itself.

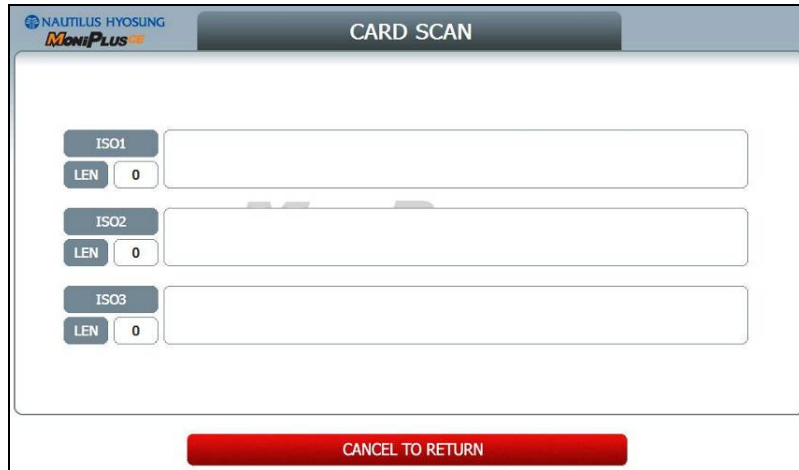

Accessing the CARD SCAN

- 1) Select **DIAGNOSTICS** in the OPERATOR FUNCTION.
- 2) Select **CARD SCAN** in the DIAGNOSTICS menu. And if the display is ready, please insert and remove the card quickly.
- 3) The card data will be displayed.

5.6.6 AUXILIARY UNIT

This **AUXILIARY UNIT** contains **SENSOR** and **FLICKER**. Please press each button on this menu to go to the next screen. To go back to the previous screen, press the **CANCEL** key in pinpad.



5.6.6.1 SENSOR

This **SENSOR** contains **CDU SENSOR** and **SPR SENSOR**. Please press each button on this menu to go to the next screen. To go back to the previous screen, press the **CANCEL** key in pinpad.

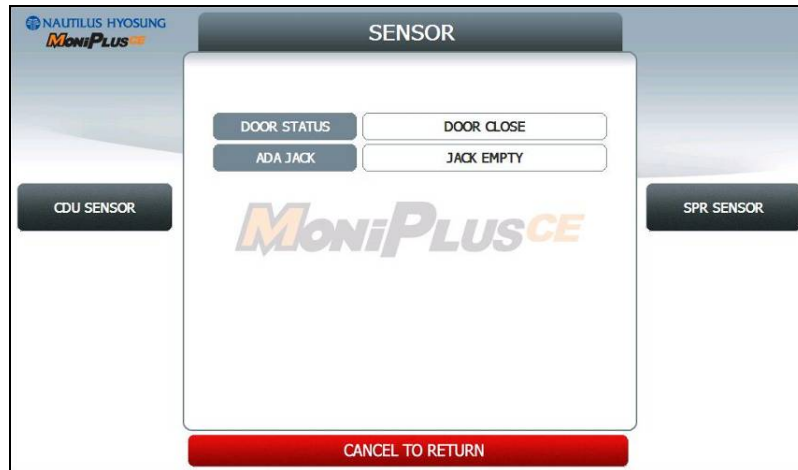

The **SENSOR** has the function of testing if all the sensors are in proper working condition. The sensors are tested by turning the sensors on and off.

Accessing the SENSOR

- 1) Select **DIAGNOSTICS** in the OPERATOR FUNCTION.
- 2) Select **AUXILIARY UNIT** in the DIAGNOSTICS menu and then select **SENSOR** in the AUXILIARY menu.
- 3) DOOR STATUS and ADA JACK data will be displayed on the center. If you want to see the **CDU SENSOR** or **SPR SENSOR**, then presses the button in each.

5.6.6.1.1 CDU SENSOR

The **CDU SENSOR** has the function of testing if all the sensors are in proper working condition. The sensors are tested by turning the sensors on and off. If any sensor is normal, the sensor will be displayed as **GREEN COLOR**. And if any sensor detects an object or is abnormal, the sensor will be displayed as **RED COLOR**. Moreover, if any sensor doesn't exist, the sensor will not be displayed.

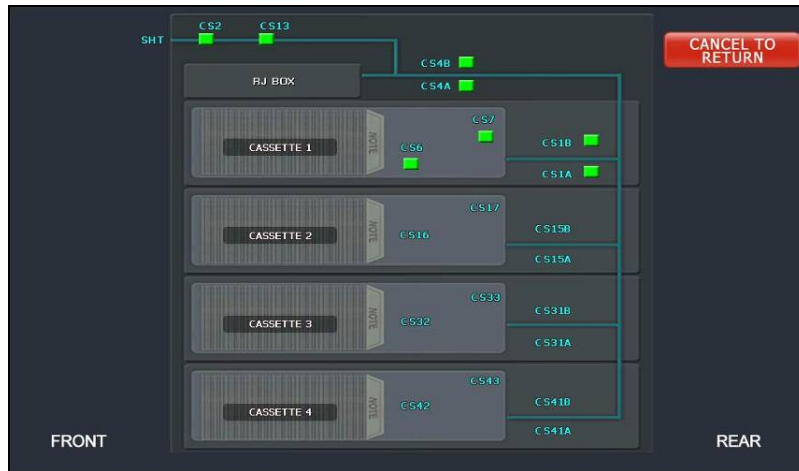

Accessing the SENSOR

- 1) Select **DIAGNOSTICS** in the OPERATOR FUNCTION.
- 2) Select **AUXILIARY UNIT** in the DIAGNOSTICS menu
- 3) Select **SENSOR** in the **AUXILIARY** menu and then select **CDU SENSOR** in the **SENSOR** menu.

5.6.6.1.2 SPR SENSOR

The **SPR SENSOR** has the function of testing if all the sensors are in proper working condition. The sensors are tested by turning the sensors on and off. If any sensor is normal the sensor will be displayed as **GREEN COLOR**. And if any sensor detects an object or is abnormal, the sensor will be displayed as **RED COLOR**. Moreover, if any sensor doesn't exist, the sensor will not be displayed.



Accessing the SENSOR

- 1) Select **DIAGNOSTICS** in the OPERATOR FUNCTION.
- 2) Select **AUXILIARY UNIT** in the DIAGNOSTICS menu
- 3) Select **SENSOR** in the **AUXILIARY** menu and then select **SPR SENSOR** in the **SENSOR** menu.

5.6.6.2 FLICKER

This **FLICKER** contains **ALL FLICKER SENSOR, EPP FLICKER, CDU FLICKER, SPR FLICKER** and **MCU FLICKER**. Please press each button on this menu to change test mode ON, OFF or FLICKING. To go back to the previous screen, press the **CANCEL** key in pinpad.

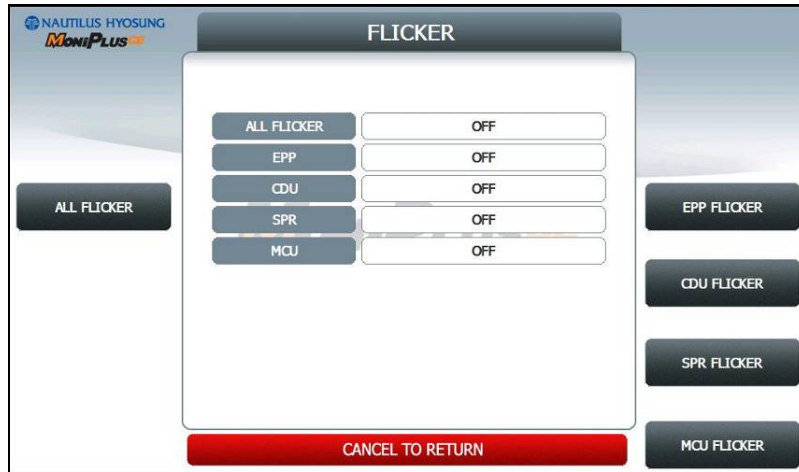

Accessing the SENSOR

- 1) Select **DIAGNOSTICS** in the OPERATOR FUNCTION.
- 2) Select **AUXILIARY UNIT** in the DIAGNOSTICS menu and then select **FLICKER** in the **AUXILIARY** menu.
- 3) Select any button to test EPP, CDU, SPR, MCU in each or ALL FLICKER.

5.6.7 AGING

The AGING function is only used at the factory.

Accessing the AGING

- 1) Select **DIAGNOSTICS** in the OPERATOR FUNCTION.
- 2) Select **AGING** in the **DIAGNOSTICS** menu.
- 3) All units will be tested unlimitedly. When you press **CANCEL** key, the testing will be stopped.

5.7 CUSTOMER SETUP

This customer setup menu contains **CHANGE MESSAGE**, **BIN LIST**, **OPTIONAL FUNCTION1**, **OPTIONAL FUNCTION2**, **SURCHARGE MODE**, **ADVERTISEMENT**, **STANDARD3 OPTION** and **SELECT PROCESSOR**. Please press each button on this menu to go to the next screen. To go back to the previous screen, press the **CANCEL** key in pinpad.

[STANDARD 3]

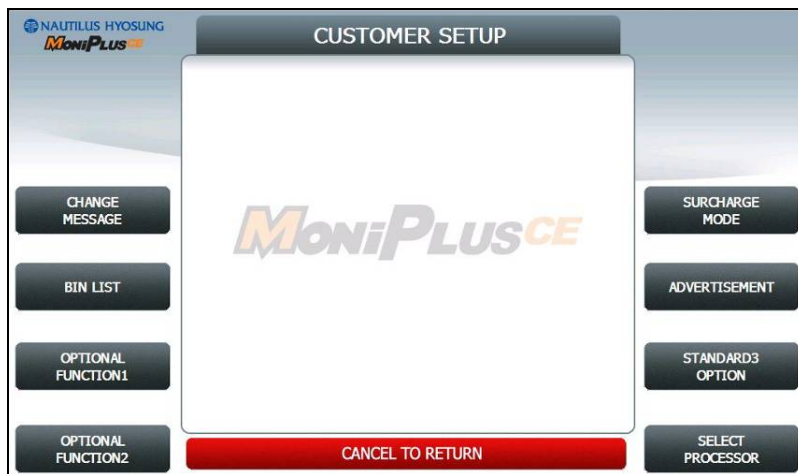

NOTE: STANDARD3 OPTION is displayed only if the message format is STANDARD3

[STANDARD 1, 2, EPS]

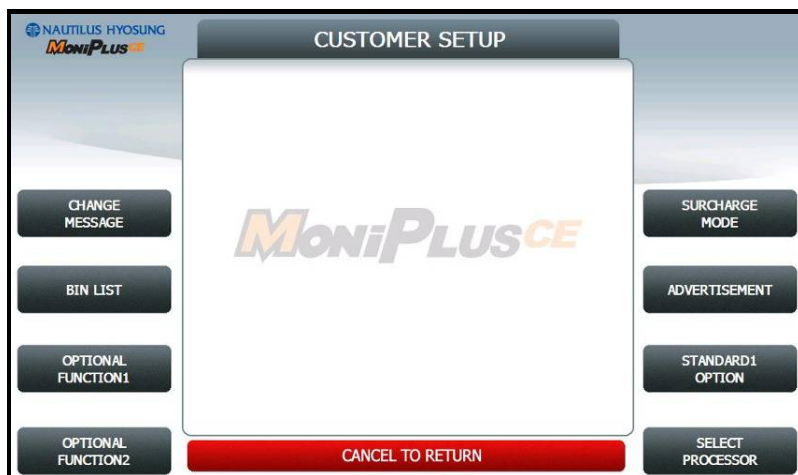

NOTE: STANDARD1 OPTION is displayed only if the message format is STANDARD1

5.7.1. CHANGE MESSAGE

CHANGE MESSAGE menu has each of 8 sub menus. The displayed menu depends on which country uses. If you press the **WELCOME MESSAGE** button, the current display will be changed into the **WELCOME MESSAGE**. If you press the **EXIT MESSAGE** button, you can change the message on Exit Screen. And you can change the message in the **RECEIPT**. If you press the **RECEIPT HEADER** button, the current display will be changed into the **RECEIPT HEADER**. And you can set the receipt header message in the **RECEIPT**, If you press the **RECEIPT TAIL** button, the current display will be changed into the **RECEIPT TAIL**. And you can set the receipt tail message in the **RECEIPT**. If you press the **RECEIPT ADDRESS & PHONE NUMBER** button, it will be changed the **RECEIPT ADDRESS & PHONE NUMBER** display. You can set the information about **ADDRESS** and **PHONE NUMBER** in the **RECEIPT**. At last, the display can go back to the previous menu by pushing the **CANCEL** key in pinpad



Refer to figure of the Sample Receipt below for the location of the messages. The default receipt format will not include any messages.

Spanish transactions will be printed in English.

TRANSACTION RECORD	
— Customer Copy —	
Thank You for Using Us!!	
<u>RECEIPT ADDRESS 1</u>	
<u>RECEIPT ADDRESS 2</u>	
<u>RECEIPT ADDRESS 3</u>	
<u>RECEIPT PHONE NUMBER</u>	
<u>RECEIPT HEADER 1</u>	
<u>RECEIPT HEADER 2</u>	
TERMINAL #	= NH2700
SEQUENCE #	= 0001
AUTH #	= 120524 90
DATE & TIME	= 05/10/2010 13:27:05
BUSINESS DATE	= 05/10/2010
CARD NUMBER	= *****8444
TRANSACTION	= WITHDRAWAL
ACCOUNT	= FROM CHECKING

DISPENSED AMOUNT =	\$20.00
REQUESTED AMOUNT =	\$20.00
SURCHARGE AMOUNT =	\$1.50
TOTAL AMOUNT =	\$21.50
LEDGER BALANCE =	\$3,567.80
AVAILABLE BALANCE =	\$3,567.80
SURCHARGE PAID TO:	
OWNER	

APPROVED	
<u>RECEIPT TAIL</u>	
SEQ.#: 0354	JNL.#: 0008

-Location of Messages on Receipt-

5.7.1.1 WELCOME MESSAGE

The **WELCOME MESSAGE** function is used to edit the welcome text. Please input the welcome message in the field and select **OK** button. If it succeeded, “**OPERATION SUCCESSFUL!**” displays

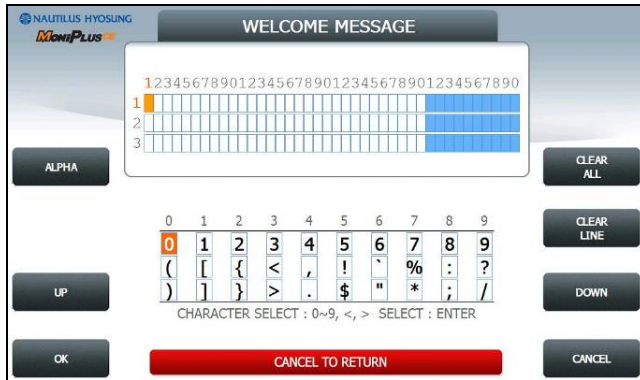

[Function Key Type]



[Touch Type]

5.7.1.2 RECEIPT HEADER

The **RECEIPT HEADER** function is used to edit the message at the header of receipt.

Please input the receipt header in the field and select **OK** button. If it succeeded, “**OPERATION SUCCESSFUL!**” displays.

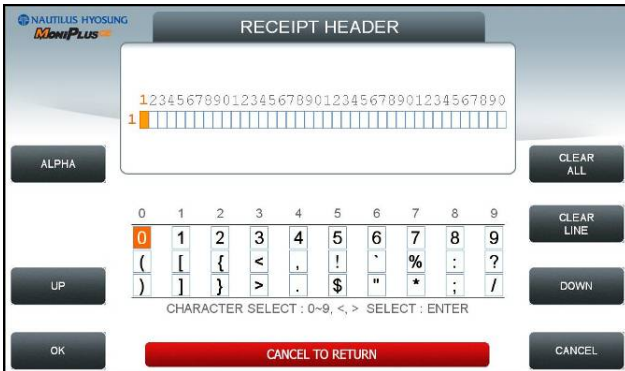

[Function Key Type]



[Touch Type]

5.7.1.3 RECEIPT TAIL

The **RECEIPT TAIL** function is used to edit the message at the tail of receipt.

Please input the receipt tail in the field and select **OK** button. If it succeeded, “**OPERATION SUCCESSFUL!**” displays.

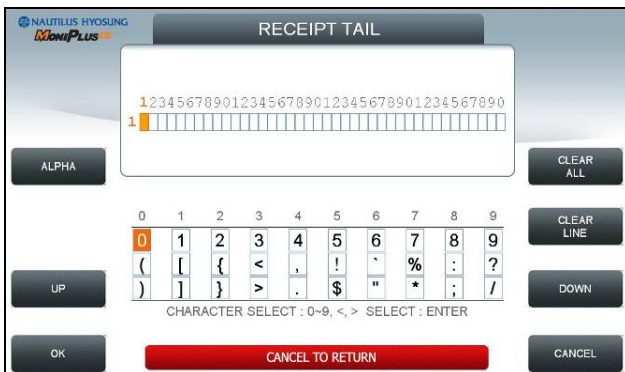

[Function Key Type]

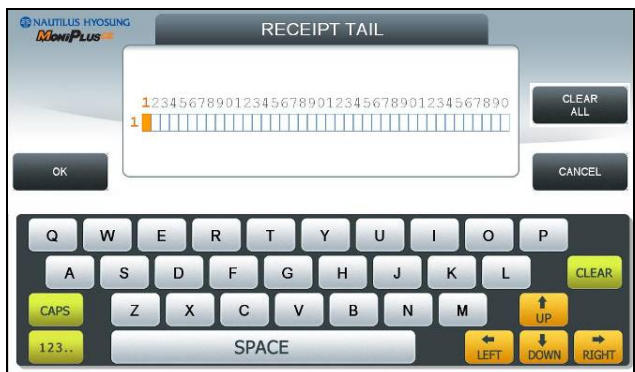

[Touch Type]

5.7.1.4 RECEIPT ADDRESS & PHONE NUMBER

The **RECEIPT ADDRESS & PHONE NUMBER** function is used to edit the message at the address & phone number of receipt.

Please input the receipt address & phone number in the field and select **OK** button. If it succeeded, **“OPERATION SUCCESSFUL!”** displays.

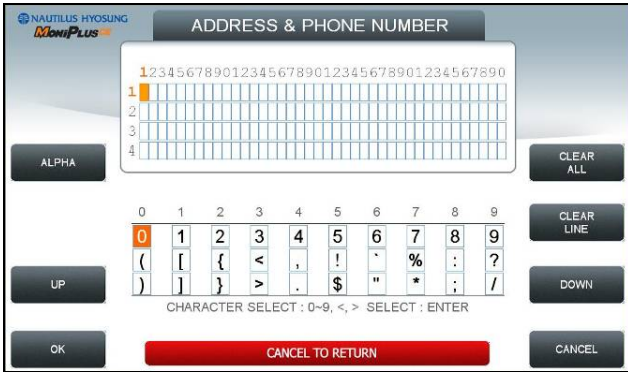

[Function Key Type]

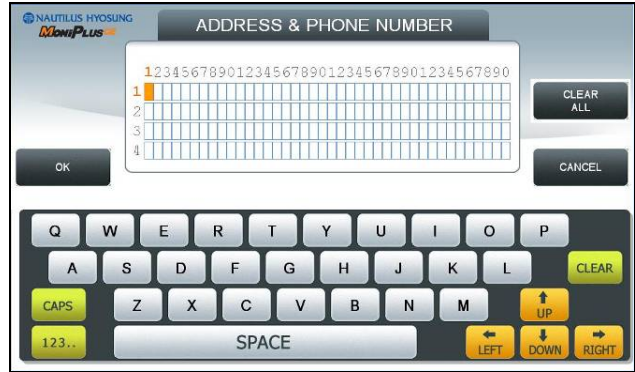

[Touch Type]

5.7.2. BIN (Bank Identification Number) LIST

The **BIN LIST** is used to register the bank identification number. When the cardholders make transaction with the given BIN code, ATM doesn't request any additional fee. However, it is necessary to confirm the connected host because host will decide whether it uses or not

You can input and edit it by using such as **ADD, DELETE, EDIT, DELETE ALL** buttons.

Please press **EXTENDED BIN LIST** button on this menu to see the Extended Bin List. To go back to the previous screen, press the **CANCEL** key in pinpad.



5.7.2.1 EXTENDED BIN LIST

EXTENDED BIN LIST menu show the BIN LIST. This function support additional 3,000 BIN LIST exclusive of the basic 20 BIN LIST. Use **PREV** or **NEXT** button to show BIN LIST before or after. You can change EXTENDED BIN LIST via **FILE UPDATE** using RMS or USB. To go back to the previous screen, press the **CANCEL** key in pinpad.

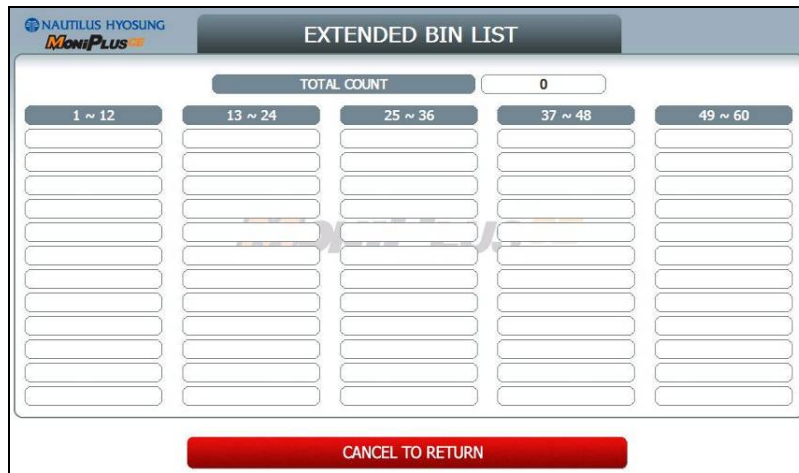

5.7.3 OPTIONAL FUNCTION1

OPTIONAL FUNCTION1 menu contains **MOD 10 CHECK**, **BALANCE AT START**, **CHECK CASHING**, **ACCOUNTS**, **SELECT RECEIPT** and **PRE DIALING** please press each button on this menu to go to next screen.

To go back to the previous screen, press the **CANCEL** Key in pinpad

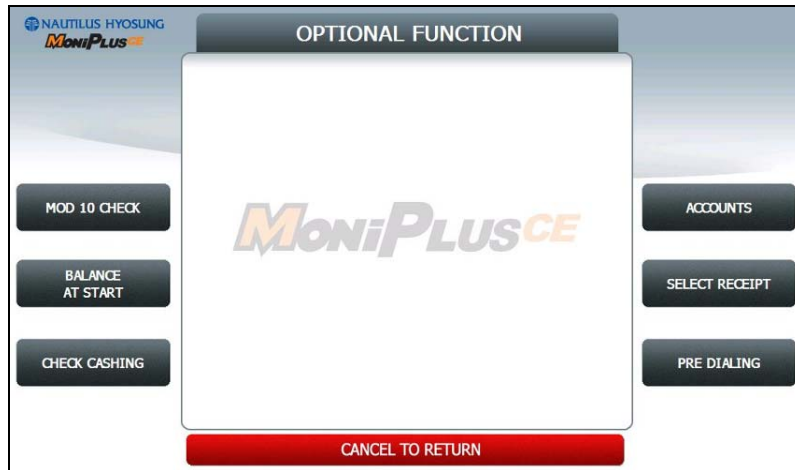

NOTE:

- 1) **CHECK CASHING** is displayed only if the message format is STANDARD1
- 2) **PRE DIALING** is displayed only if Network is Dial up

5.7.3.1 MOD 10 CHECK

MOD 10 CHECK is to check the card data's validation.

Please press **EN/DISABLE** button to set up **MOD 10 CHECK**.

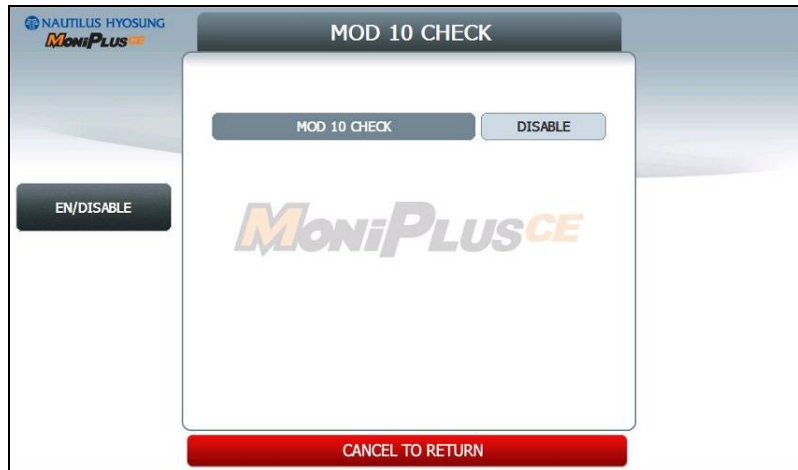

5.7.3.2 BALANCE AT START

If **BALANCE AT START** is enabled, the screen with which a customer can check his/her balance will be inserted into the normal transaction flow.

Please press **EN/DISABLE** button to set up **BALANCE AT START** and **CONTINUE EN/DISABLE** button to set up whether it'll **CONTINUE** the **TRANSACTION** after **BALANCE AT START** . .

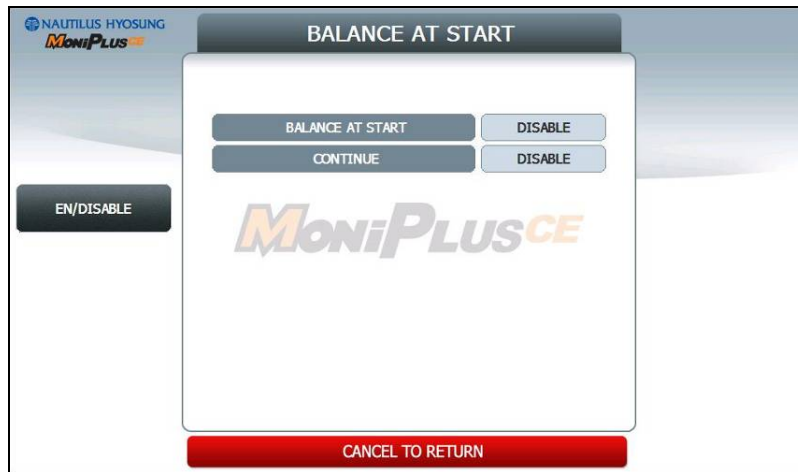

5.7.3.3 CHECK CASHING

This function is one of the options of the Value Added Service which exchanges checks for cash.

To use the function, you should call technical support.

The certification screen will appear if you didn't certified.

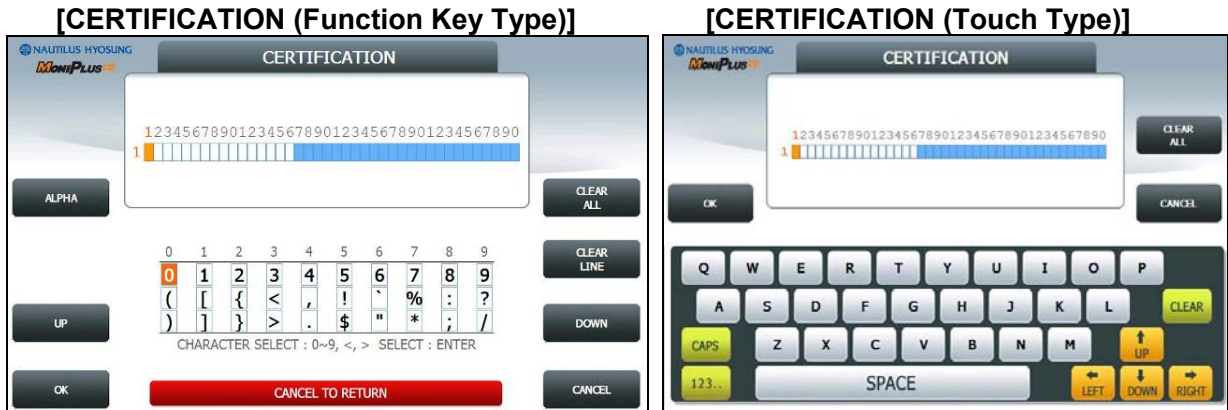

5.7.3.4 ACCOUNTS

ACCOUNTS are to set up the accounts which are used on transaction. You can see CHECKING ACCOUNT, SAVINGS ACCOUNT and CREDIT CARD ACCOUNT however, only **CREDIT CARD ACCOUNT** can be set up.

Please press **CREDIT CARD EN/DISABLE** button to set up **CREDIT CARD ACCOUNT**.



5.7.3.5 SELECT RECEIPT

If **SELECT RECEIPT** is **ENABLED**, ATM will show the screen which a customer can select whether printing the receipt after a transaction or not.

Please press **EN/DISABLE** button to set up **SELECT RECEIPT**...

If **SELECT RECEIPT** is **DISABLED**, ATM will print out the receipt unconditionally.

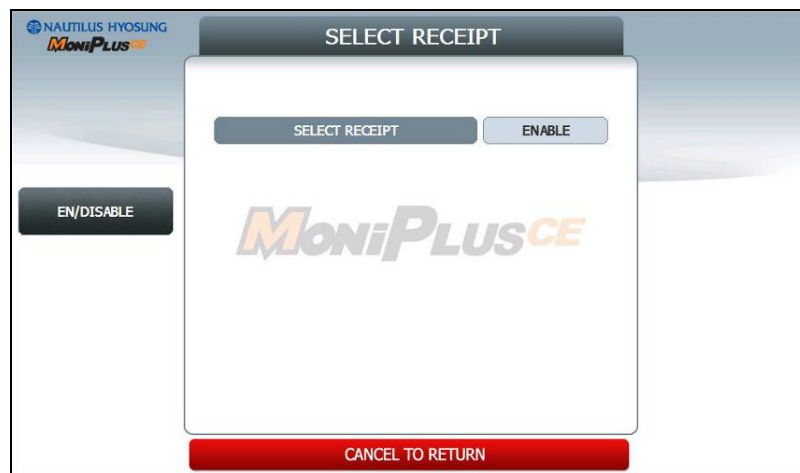

5.7.3.6 PRE DIALING

PRE DIALING is a function to improve the performance speed of transaction by making a connection to the host server earlier than normal.

Please press **EN/DISABLE** button to set up **PRE DIALING** and one of three buttons (**AFTER CARD**, **AFTER PIN** and **AFTER ACCOUNT**) to determine the time when ATM makes a connection.



5.7.4 OPTIONAL FUNCTION2

OPTIONAL FUNCTION2 menu contains **DEVICE OPTION** and **SCREEN SERVICES**.

To go back to the previous screen, press the **CANCEL** Key in pinpad

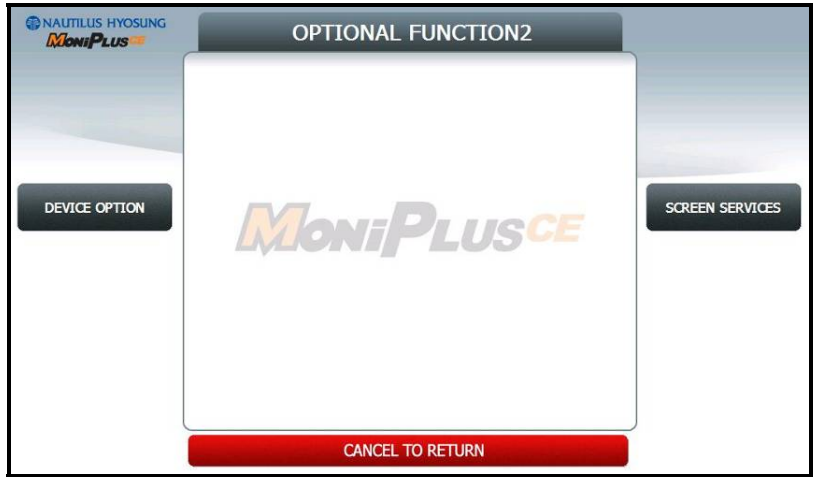

5.7.4.1 DEVICE OPTION

DEVICE OPTION menu contains **RECEIPT PAPER LOW SENSOR EN/DISABLE**, **CST SOUND ON/OFF**, **EPP FLICKER ON OPTION**. Please press each button on this menu to set up items.

To go back to the previous screen, press the **CANCEL** Key in pinpad

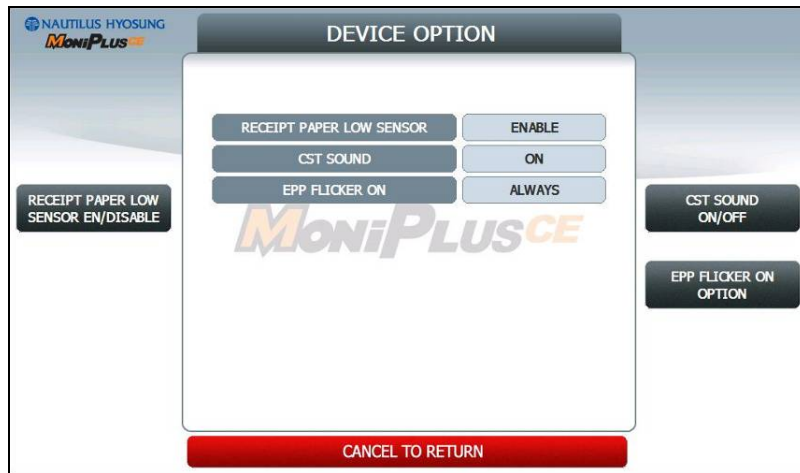

5.7.4.2 SCREEN SERVICES

SCREEN SERVICES menu contains **CHANGE BACKGROUND** and **NOTICE**

Please press **CHANGE BACKGROUND** and **NOTICE** button on this menu to go to next screen.

To go back to the previous screen, press the **CANCEL** Key in pinpad



5.7.4.2.1 CHANGE BACKGROUND

CHANGE BACKGROUND function provides **SIX** different Background screens.

Please press **EN/DISABLE** button on this menu to set up for **CHANGE BACKGROUND**.

To go back to the previous screen, press the **CANCEL** Key in pinpad

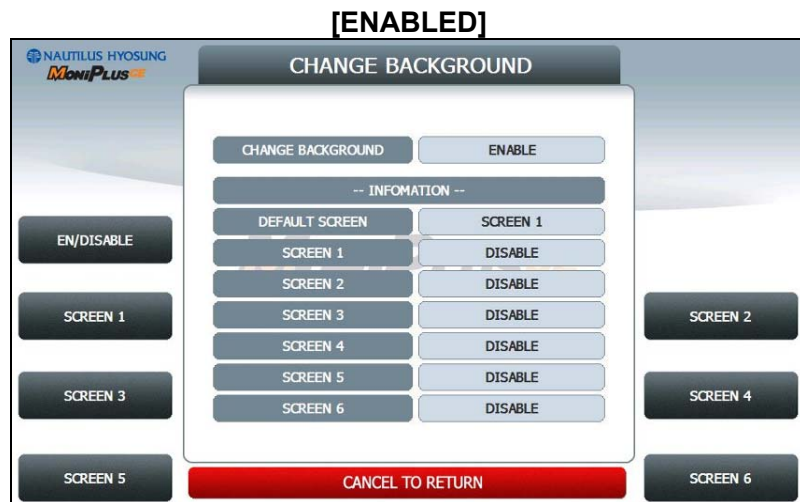

The change background image can be updated by SW Update with JPG format images. For more information, please refer to “**Background image Update Guide**” document.

5.7.4.2.1.1 CHANGE BACKGROUND Screen n

Please press **SCREEN n EN/DISABLE** button to set up SCREEN n,

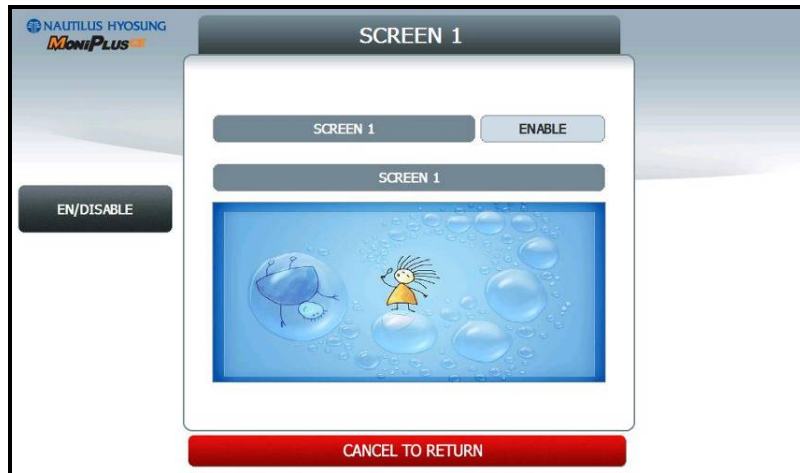

5.7.4.2.2 DEFAULT SCREEN

DEFAULT SCREEN function provides **SIX** different Background screens.

You can set up only one screen on the six screens

Please press **DEFAULT SCREEN n EN/DISABLE** button to set up SCREEN n,

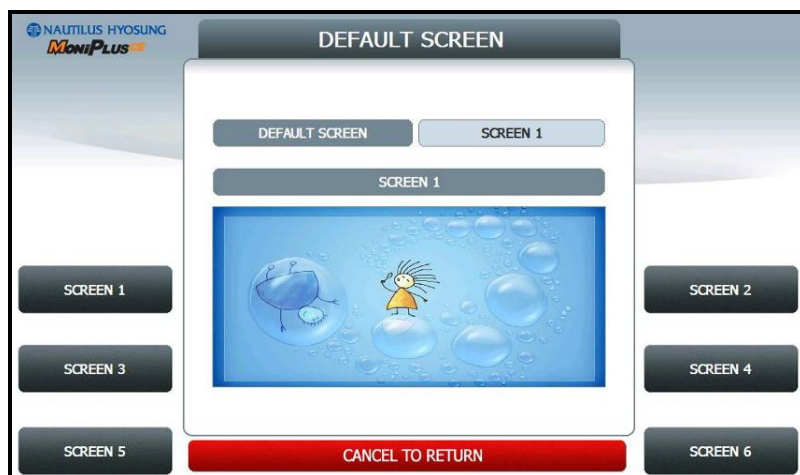

5.7.4.2.3 NOTICE (NH2700 Only)

NOTICE menu contains **TITLE** and **MESSAGE**.

You can set up **TITLE(1 line 30 column)** and **MESSAGE(3 line 40 column)**.

If you set up **NOTICE ENABLE**, ATM will be displayed notice information on idle screen.

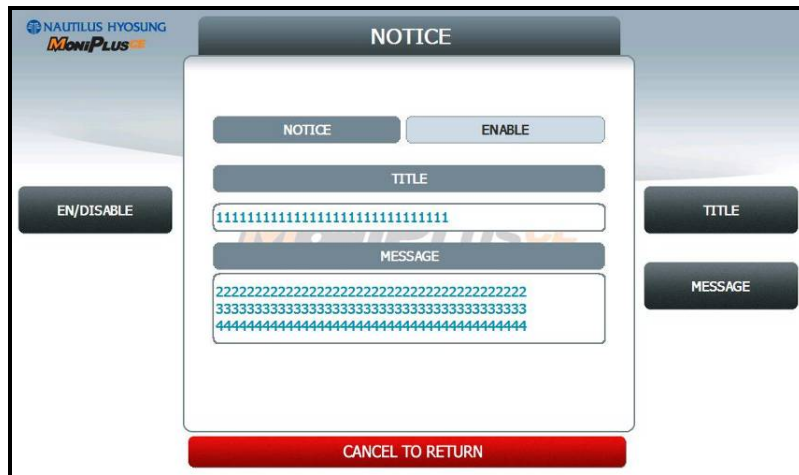

5.7.5. SURCHARGE MODE

The **SURCHARGE MODE** contains the enable/disable of the surcharge warning screen and setting the surcharge amount and surcharge owner. When the **SURCHARGE MODE** is disabled and also if the swiped card data contains BIN number that was entered during installation, the surcharge warning message will not be displayed. When the **SURCHARGE MODE** is enabled, the **SURCHARGE OWNER**, **AMOUNT** and **SURCHARGE PERCENT** will be displayed in the surcharge warning screen during transaction. The factory default is surcharge enabled, surcharge amount is \$1.50 and the surcharge owner is none.

SURCHARGE PERCENT is to set up the percentage of surcharge.

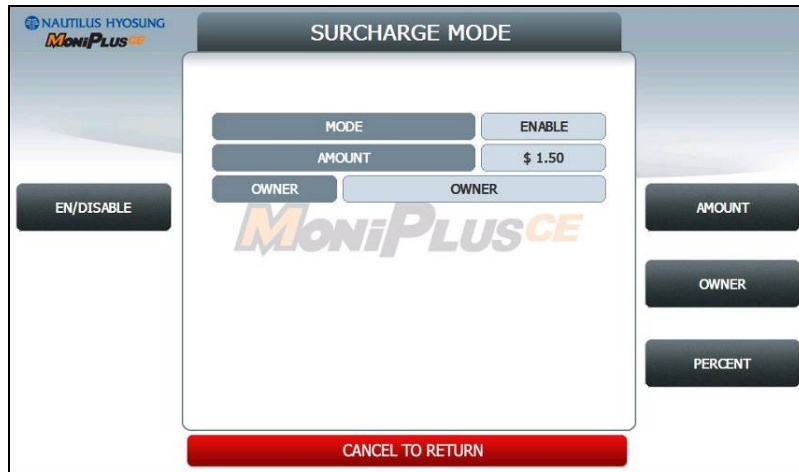

5.7.5.1 SURCHARGE OWNER

The **SURCHARGE OWNER** function is used to edit the surcharge owner.

Please input the surcharge owner in the field and select **OK** button. If it succeeded, **“OPERATION SUCCESSFUL!”** displays.

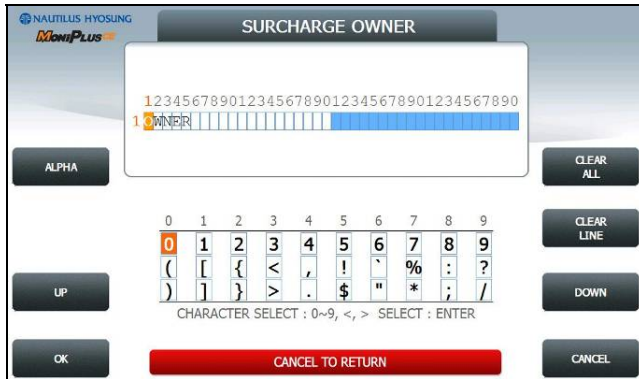

[Function Key Type]



[Touch Type]

5.7.5.2 SURCHARGE PERCENT

The **SURCHARGE PERCENT** displays which are to set the surcharge percent.

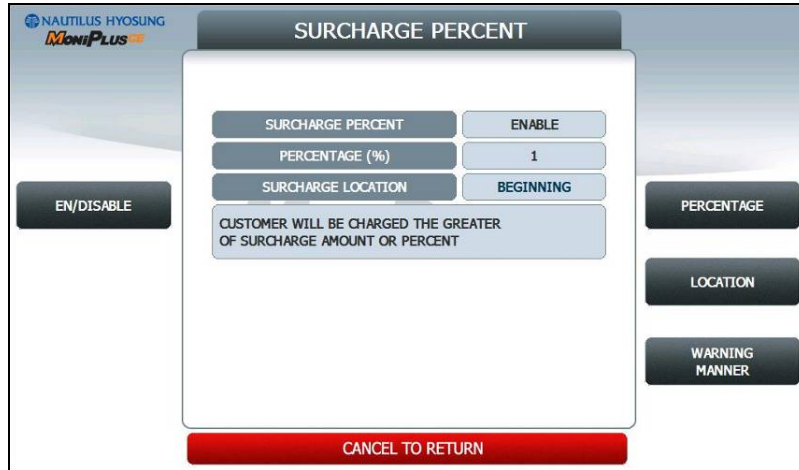

1) **EN/DISABLE**

- Set whether to use PERCENT SURCHARGE MODE.

2) **PERCENTAGE**

- Set PERCENTAGE (%).

3) **WARNING MANNER**

- Set whether to use maximum value or minimum value between **PERCENTAGE** and **SURCHARGE AMOUNT**. (GREATER: Maximum value, LESSER: Minimum value.)

4) **LOCATION**

- Set surcharge warning screen option

- **BEGINNING** : Shows Surcharge warning screen before customer selected amount.

- **AFTER AMOUNT** : Shows Surcharge warning screen after customer selected amount.

5.7.6. ADVERTISEMENT

ADVERTISEMENT function provides **COUPON**, **WELCOIME ADVERTISEMENT** and **TRANSACTION ADVERTISEMENT**.

Please press each button on this menu to go to next screen.



5.7.6.1 COUPON

Please press **COUPON TYPE** button to set up **BASIC COUPON** or **ENHANCED COUPON**.

If you set the **BASIC COUPON** and select **COUPON SETTING** button, **BASIC COUPON** setting screen will be displayed.

BASIC COUPON supports 2line 39column, **ENHANCED COUPON** supports 16line 39column.

If you set the **ENHANCED COUPON** and select **COUPON SETTING** button, **ENHANCED COUPON** setting screen will be displayed.



5.7.6.1.1 BASIC COUPON SETTING

Please press each button on this menu to go to next screen



5.7.6.1.1.2 BASIC COUPON n.

Please press **BASIC COUPON n EN/DISABLE** button to set up BASIC COUPON n,
Please press **COUPON n TEXT** button on this menu to go to next screen



5.7.6.1.1.3 COUPON n. TEXT

The **COUPON n TEXT** function is used to edit the coupon n text.

Please input the welcome message in the field and select **OK** button. If it succeeded, “**OPERATION SUCCESSFUL!**” displays.

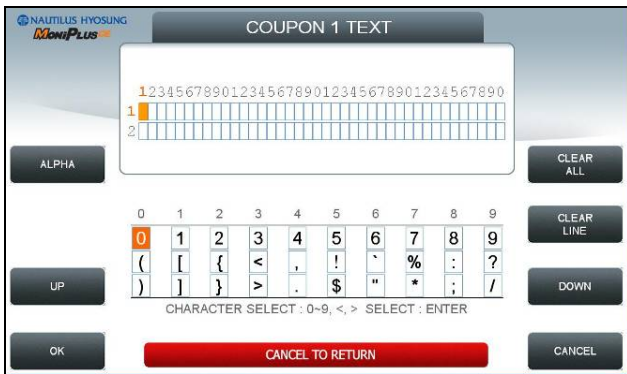

[Function Key Type]

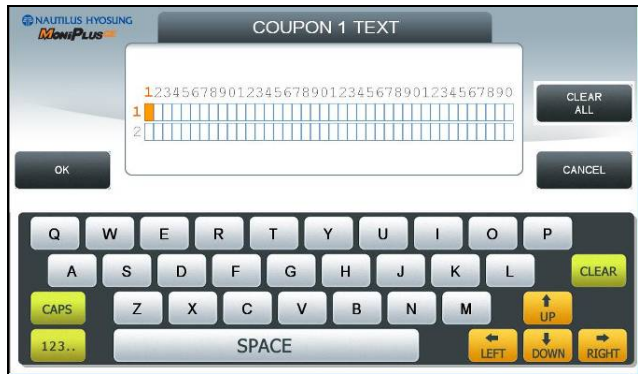

[Touch Type]

5.7.6.1.2.1 ENHANCED COUPON SETTING

Please press **CUT OPTION** button to set up **AFTER RECEIPT** or **NOT USE**,
Please press each button on this menu to go to next screen



5.7.6.1.2.2 ENHANCED COUPON n.

Please press **ENHANCED COUPON n OPTION** button to set up **NOT USE**, **ALWAYS** and **USE TIME**.
START TIME and **END TIME** is only used **USE TIME** option and the range is 00 ~ 23
Please press **COUPON n TEXT** button on this menu to go to next screen



5.7.6.1.2.3 ENHANCED COUPON n. TEXT

The **ENHANCED COUPON n TEXT** function is used to edit the coupon n text.

Please input the welcome message in the field and select **OK** button. If it succeeded, **“OPERATION SUCCESSFUL!”** displays.

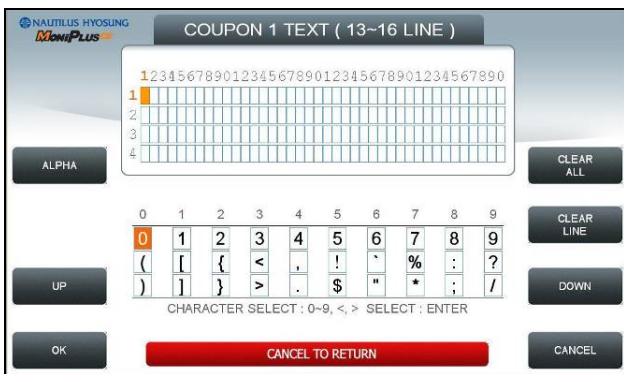
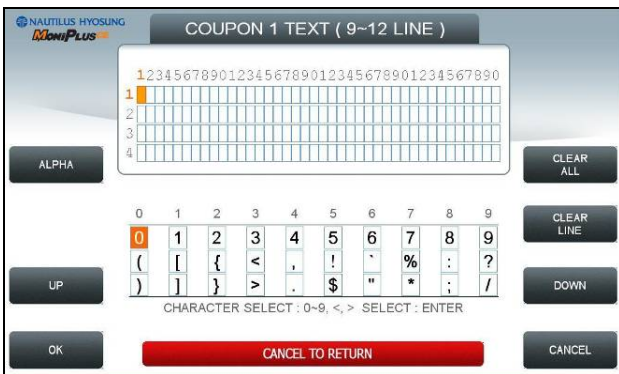
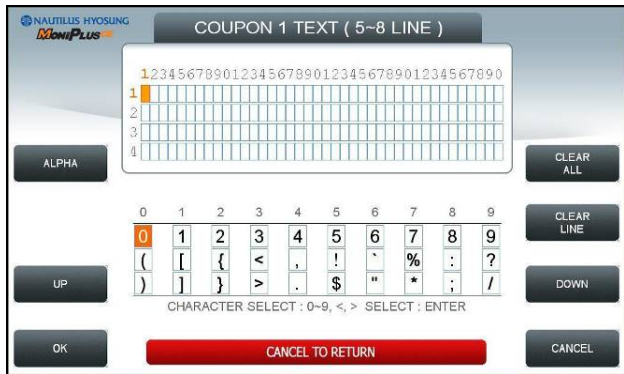
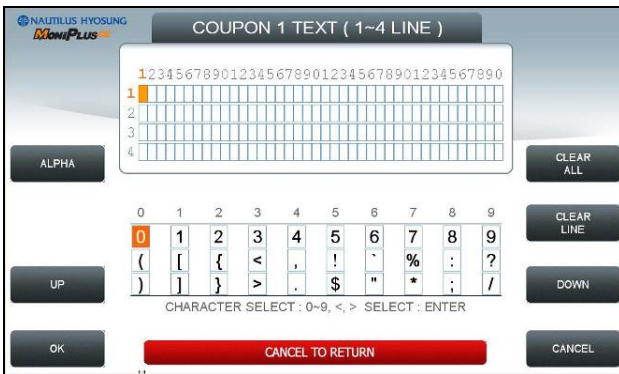

[Function Key Type]

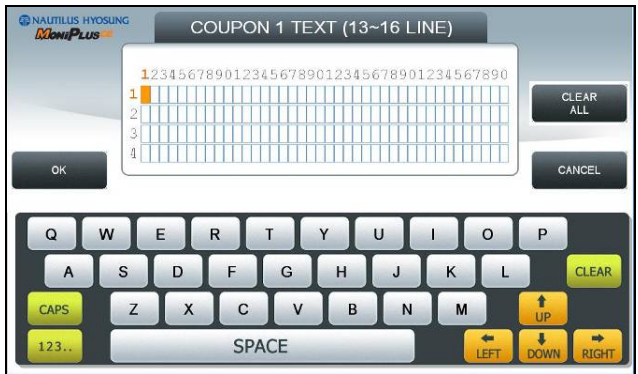
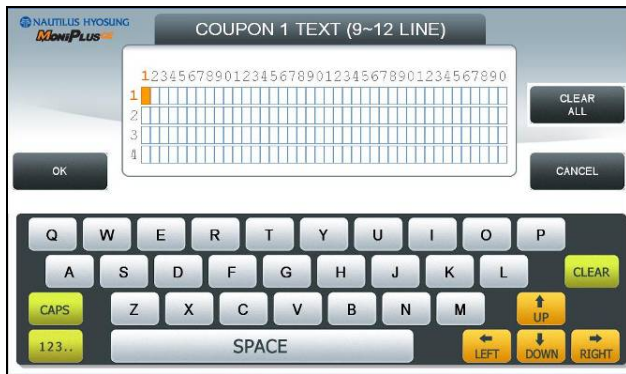
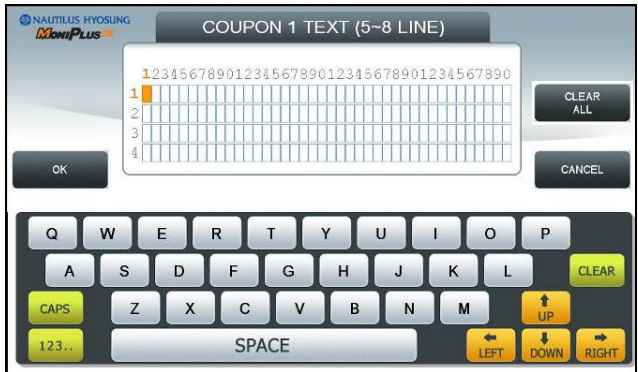
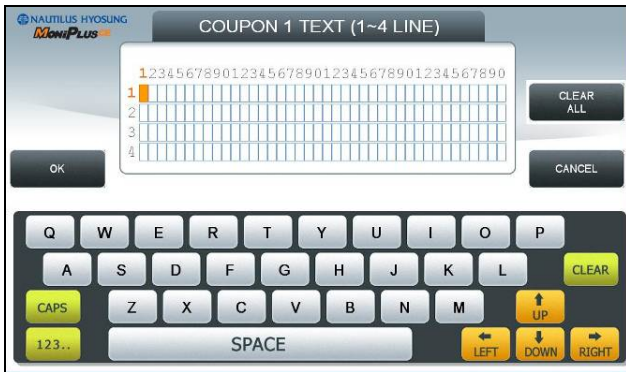

[Touch Type]

5.7.6.2 WELCOME ADVERTISEMENT

WELCOME ADVERTISEMENT function provides **SIX** different screens.

If you press the **TIMER** button, you can change the advertisement display timer and the range is between 5 and 30 in welcome screen. Please press each button on this menu to go to next screen.



The welcome advertisement image can be updated by SW Update with JPG format images. For more information, please refer to “**Image File Update Guide**” document.

5.7.6.2.1 SCREEN n.

Please press **SCREEN n EN/DISABLE** button to set up SCREEN n,



5.7.6.3 TRANSACTION ADVERTISEMENT

TRANSACTION ADVERTISEMENT function provides **SIX** different screens.

If you press the **TIMER** button, you can change the advertisement display timer and the range is between 5 and 30 in welcome screen. Please press each button on this menu to go to next screen.

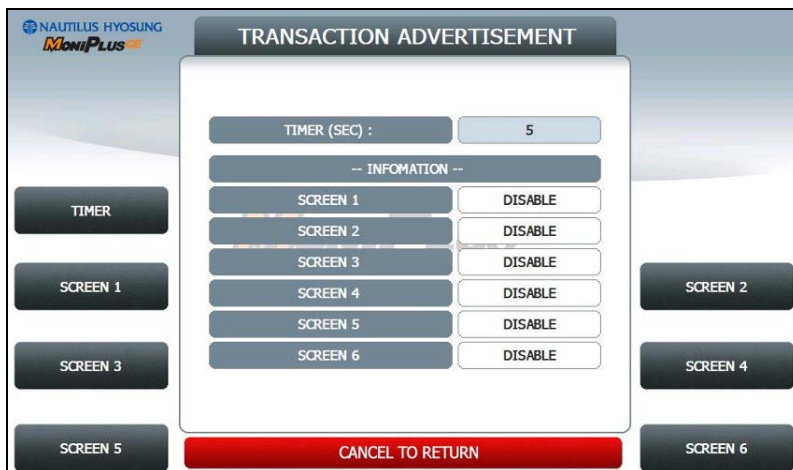

The transaction advertisement image can be updated by SW Update with JPG format images. For more information, please refer to **“Image File Update Guide”** document.

5.7.6.3.1 SCREEN n.

Please press **SCREEN n EN/DISABLE** button to set up SCREEN n,



5.7.7. STANDARD 3 OPTION

STANDARD 3 OPTION contains **STATUS MONITORING EN/DISABLE**, **COMMUNICATION HEADER**, **COMMUNICATION ID** and **CRC EN/DISABLE**.

In case of **COMMUNICATION HEADER** is enabled, **COMMUNICATION ID** option can be configured.

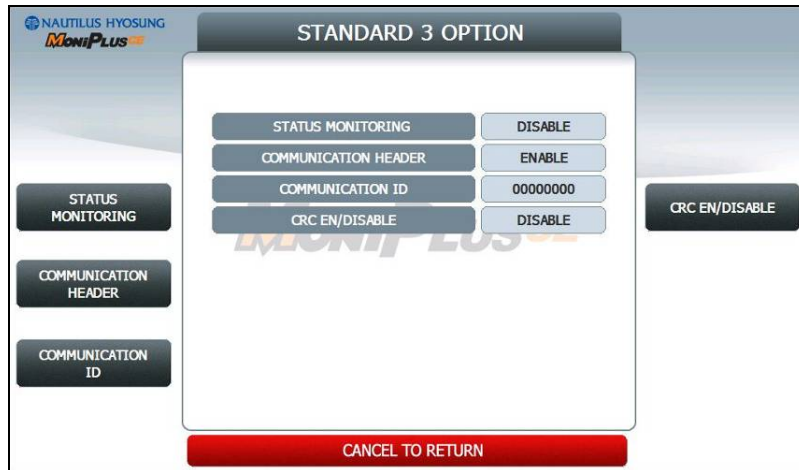

STANDARD 3 OPTION function is used to get the additional information when Triton message is selected.

- 1) **STATUS MONITORING** function is to decide whether status monitoring field in message is sent or not.
- 2) **COMMUNICATION HEADER** function is to decide whether communication header in message is included or not.
- 3) **COMMUNICATION ID** function is able to save the **COMMUNICATION ID**.
The **COMMUNICATION ID** has to be set if using the **COMMUNICATION HEADER** function.
- 4) **CRC(Cyclic Redundancy Checking) OPTION** function is to set up whether CRC is used or not during communication with host.

5.7.7.1 COMMUNICATION ID

The **COMMUNICATION ID** function is used to edit the communication id.

Please input the communication id in the field and select **OK** button. If it succeeded, **“OPERATION SUCCESSFUL!”** displays.

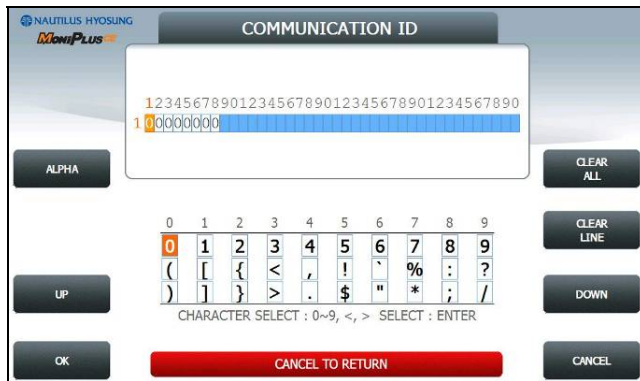

[Function Key Type]

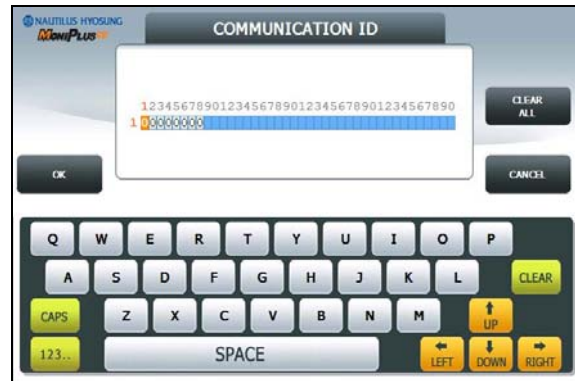

[Touch Type]

5.7.8. STANDARD 1 OPTION

STANDARD 1 OPTION contains **TERMINAL STATUS EN/DISABLE**, **HOST ERROR EN/DISABLE** and **REVERSAL REASON EN/DISABLE**.

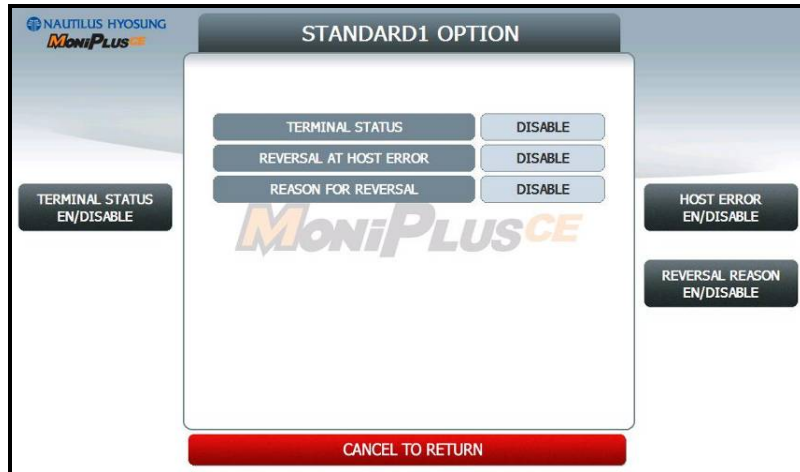

STANDARD 1 OPTION function is used to get the additional information when Triton message is selected.

- 1) **TERMINAL STATUS** function is to decide whether terminal status field in message is sent or not.
- 2) **HOST ERROR** function is to decide whether reversal message is sent or not when communication error occurred.
- 3) **REVERSAL REASON** function is to decide whether reason code("n") is sent or not when reversal message is sent to the host.

5.7.9. SELECT PROCESSOR

SELECTHOST menu contains **COMMUNICATION**, **MESSAGE FORMAT**, **EOT/ENQ OPTION**, **TCP/IP TYPE** and **REVERSAL RETRY COUNT**

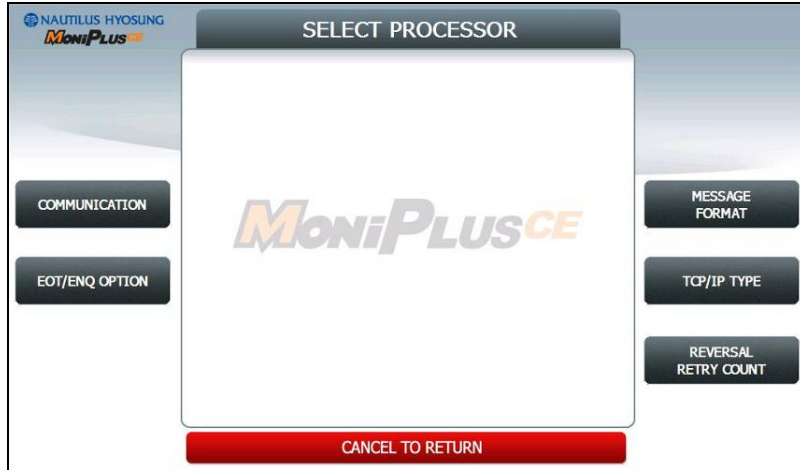

NOTE:

- 1) **EOT / ENQ OPTION** is displayed only if the Network is Dial up or TCP/IP Type is VISA FRAMED
- 2) **TCP/IP TYPE** is displayed only if Network is TCP/IP

5.7.9.1 COMMUNICATION

This is to set up a type of line to communicate with Host. Select **DIALUP** or **TCP/IP**. In case of setting up DIALUP, communicate with host using modem. And in case of setting up TCP/IP, communicate with host using LAN.

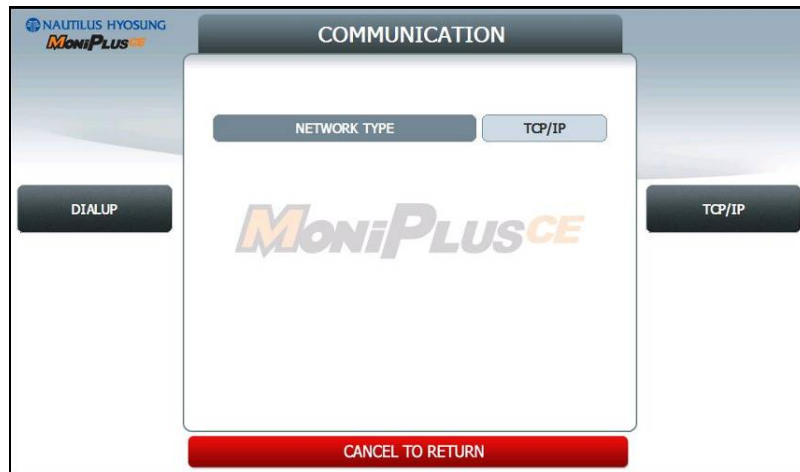

NOTE: In case of selecting "IN SERVICE" on OP MAIN, if the value is different from the original value when entering in OP mode, exit OP and execute reboot.

5.7.9.2 EOT/ENQ OPTION

EOT/ENQ OPTION contains GENERAL, EOT OPTIONAL, NO EOT REQUIRED and NO ENQ REQUIRED functions. You can select one of these options

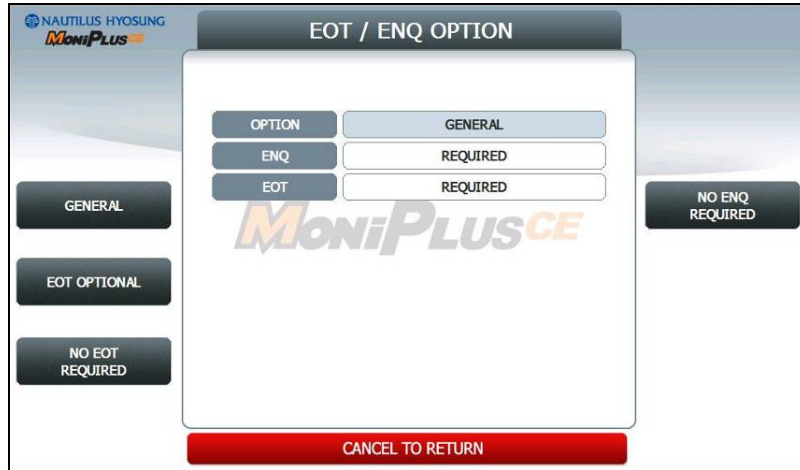

5.7.9.3 MESSAGE FORMAT

This menu sets up message format to use during communicating with Host.

You can select one of message type to communicate with a data processing company or bank in this menu (**STANDARD1**, **STANDARD2**, **STANDARD3** and **EPS**). If **STANDARD3** is selected, **STANDARD3 OPTION** button is displayed on the **CUSTOMER SETUP** Screen.

STANDARD 1 is a HYOSUNG message type and **STANDARD 2** is a CSP200 message type, **STANDARD 3** is Triton 9600 message type and **EPS** is an extended CSP200 message type.

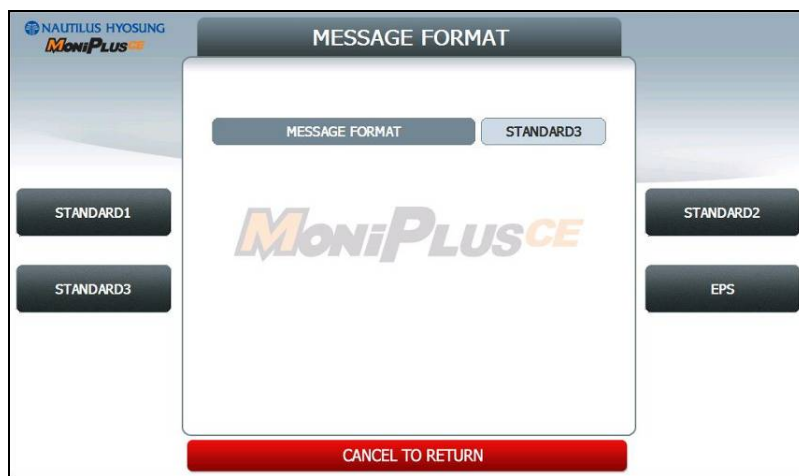

5.7.9.4 TCP/IP TYPE

In case of supporting **TCP/IP**, this is providing a function setting up communication flow to use when communicating with host. In this menu, you can change **TCP/IP TYPE** and can decide whether 'ENABLE' or 'DISABLE' about **SSL OPTION**. There are three kind of **TCP/IP** type in this TCP/IP COMMUNICATION menu

(STANDARD TCP/IP, VISA FRAMED TCP/IP, and ACK CONTROLLED TCP/IP).

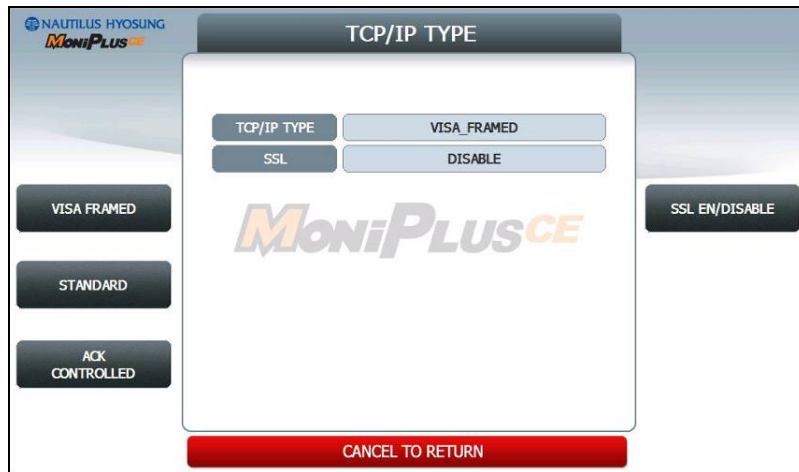

5.7.9.5 REVERSAL RETRY COUNT

REVERSAL RETRY COUNT function is used to set the try count of reversal transaction. **CURRENT REVERSAL RETRY COUNT** displays count of current setting value. You can enter the count and then press **ENTER** (or **CONFIRM**) if you want to change try count of reversal transaction. (You should ask your DP about count of reversal transaction before change try count.)

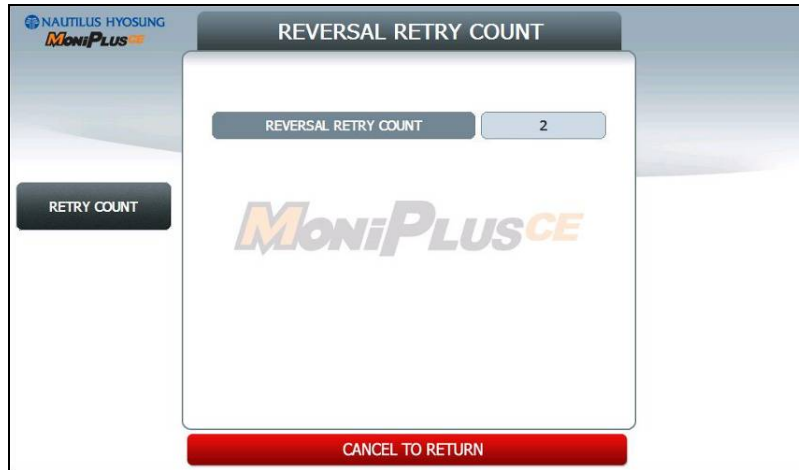

5.8 SYSTEM SETUP

This system setup menu contains **DATE & TIME**, **CHANGE PASSWORD**, **SPEAKER VOLUME**, **MODEM PARAMETERS**, **TERMINAL IP**, **DEVICE SETUP**, **LANGUAGE EN/DISABLE** and **SYSTEM CONTROL**.

Please press each button on this menu to go to next screen. To go back to the previous screen, press the **CANCEL** key in pinpad.



NOTE:

- 1) **TERMINAL IP** is displayed only if the Network is TCP/IP.
- 2) **MODEM PARAMETERS** is displayed only if Network is Dial up.

5.8.1 DATE & TIME

You can set system date and time by pressing **YEAR**, **HOURL**, **MONTH**, **MINUTE** and **DAY** button. If you press each menu, the cursor will be positioned and you can change the value. This value is saved by pressing **APPLY** key, on the other hand, to go back to the previous screen, press the **CANCEL** key in pinpad.



5.8.2 SPEAKER VOLUME

The **SPEAKER VOLUME** function is used to set speaker volume by using **DOWN** and **UP** buttons. Once the button is pressed, ATM beeps.

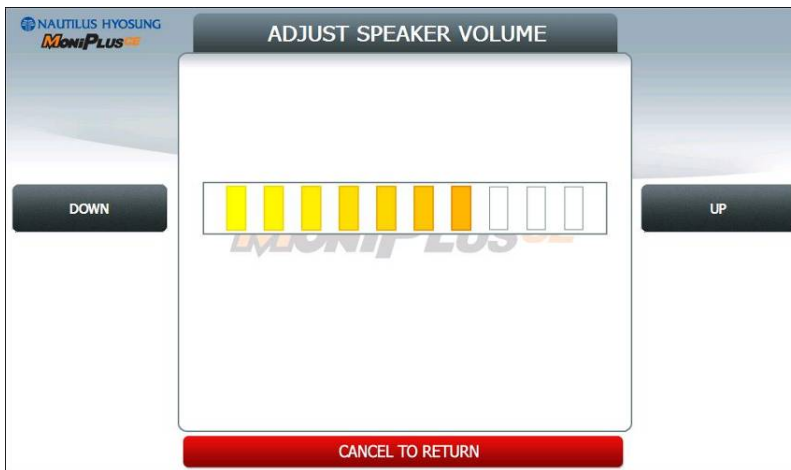

5.8.3 TERMINAL IP

TERMINAL IP menu contains **DHCP EN/DISABLE**, **IP ADDRESS**, **SUBNET MASK**, **GATEWAY** and **DNS** buttons. If you press **DHCP EN/DISABLE** button will change DHCP status, ENABLE to DISABLE, or DISABLE to ENABLE. In case of DHCP is disabled, **IP ADDRESS**, **SUBNET MASK**, **GATEWAY** and **DNS** buttons will be displayed.

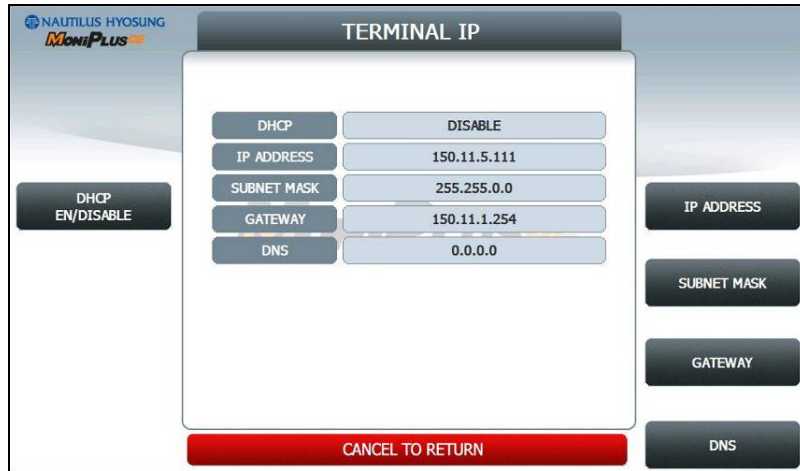

If **DHCP** value is **ENABLE**, ATM uses **DYNAMIC IP** to connect to host. Otherwise, ATM uses **STATIC IP**. If you change DHCP value from **ENABLE** to **DISABLE**, you should set up **STATIC IP** again use **IP ADDRESS**, **SUBNET MASK**, **GATEWAY** and **DNS** buttons.

It is able to input up to 15 units such as XXX.XXX.XXX.XXX

5.8.4 LANGUAGE EN/DISABLE

You can select language type to be displayed in screen. There are three types of language **ENGLISH**, **SPANISH**, **FRENCH**. You can change default language pressing **DEFAULT LANGUAGE SELECT** button. If you press each **EN/DISABLE** button, one of ENABLE/DISABLE will be changed.

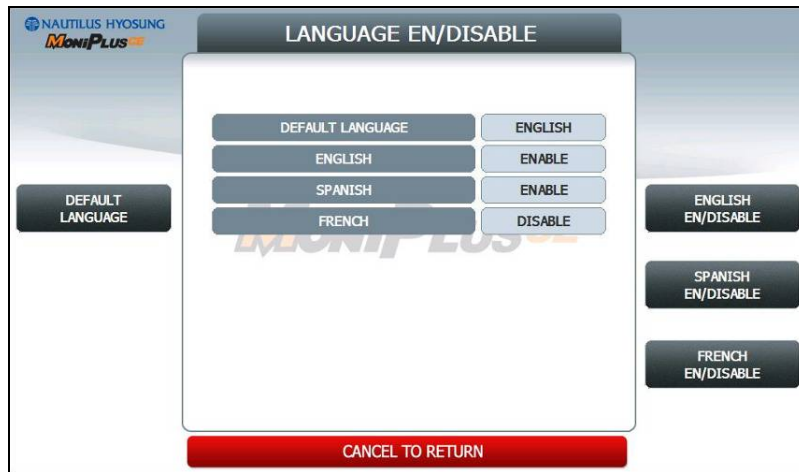

NOTE: The Language which is selected as **DEFAULT LANGUAGE** cannot be changed.

5.8.5 CHANGE PASSWORD

You can change PASSWORD. Depending on authority, there are three passwords **OPERATOR PASSWORD**, **SERVICE PASSWORD** and **MASTER PASSWORD**.

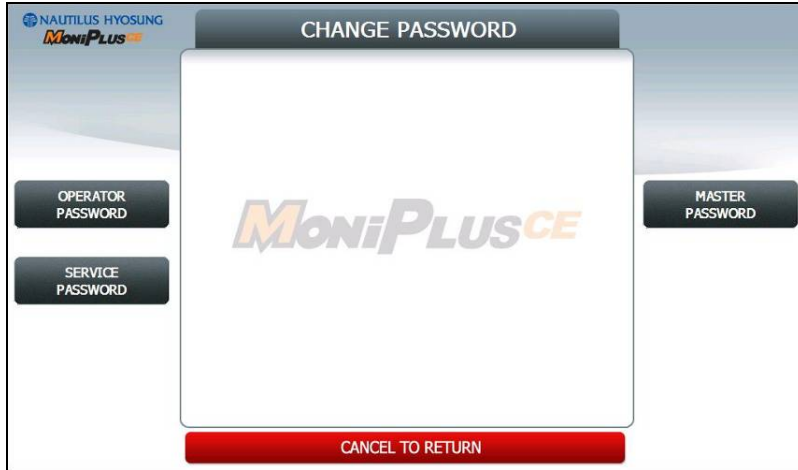

5.8.5.1 OPERATOR PASSWORD

This menu enables you to change current operator password as new one. To change the current password, you should input the proper one in current password field. The factory default value of operator password is "111111".



5.8.5.2 SERVICE PASSWORD

This menu enables you to change current service password as new one. To change the current password, you should input the proper one in current password field. The factory default value of service password is "222222".



5.8.5.3 MASTER PASSWORD

This menu enables you to change current master password as new one. To change the current password, you should input the proper one in current password field. The factory default value of master password is "555555".



5.8.6 MODEM PARAMETERS

This MODEM PARAMETERS menu contains **HOST INITIAL STRING**, **RMS INITIAL STRING** and **MODEM TEST**.

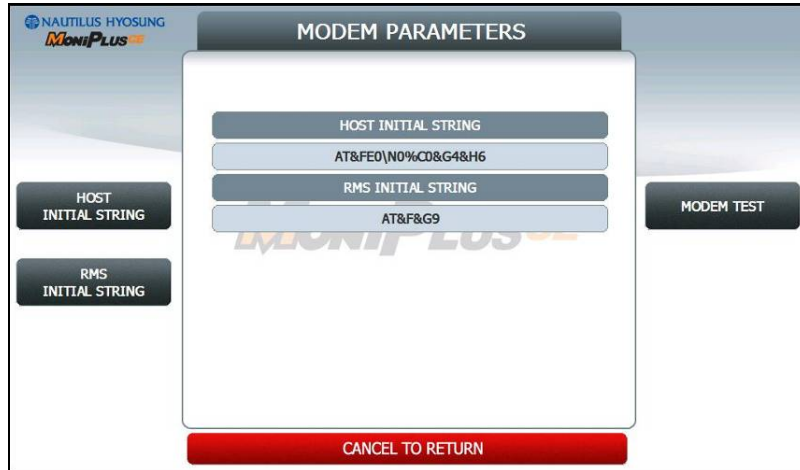

1) INITIAL STRINGS

The **HOST INITIAL STRING** and **RMS INITIAL STRING** functions are used to edit the modem initial string when the special circumstance is required by a nonstandard modem initial string. Before editing the initial string, consult with service personnel.

2) MODEM TEST

The **MODEM TEST** function is used to perform the modem reset test. When the error is occurred, contact the service personnel.

5.8.6.1 HOST INITIAL STRING

The **HOST INITIAL STRING** function is used to edit the host initial string.

Please input the host initial string in the field and select **OK** button. If it succeeded, “**OPERATION SUCCESSFUL!**” displays.

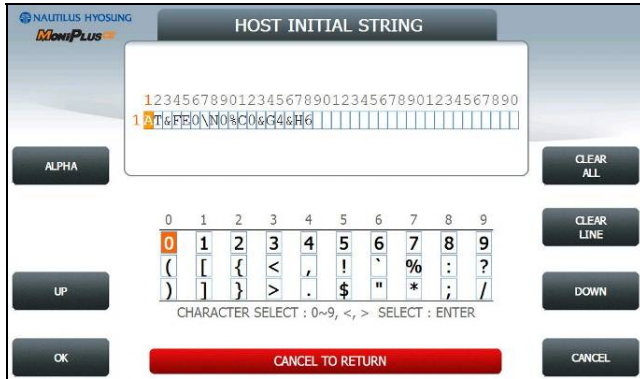

[Function Key Type]



[Touch Type]

5.8.6.2 RMS INITIAL STRING

The **RMS INITIAL STRING** function is used to edit the rms initial string.

Please input the rms initial string in the field and select **OK** button. If it succeeded, “**OPERATION SUCCESSFUL!**” displays.

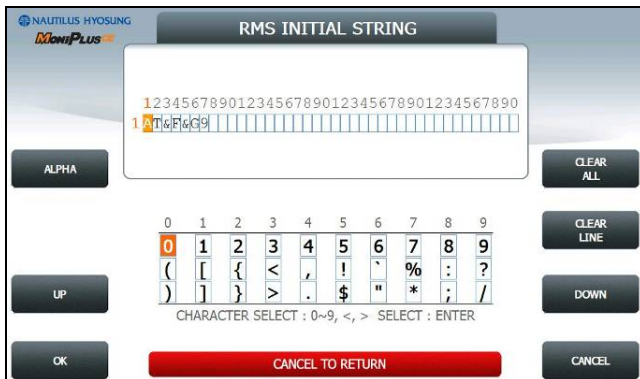

[Function Key Type]

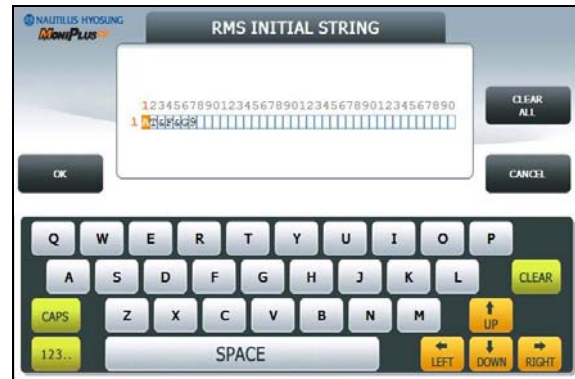

[Touch Type]

5.8.7 DEVICE SETUP

This **DEVICE SETUP** menu contains **CDU SETUP**. Please press the **CDU SETUP** button on this menu to go to next screen.

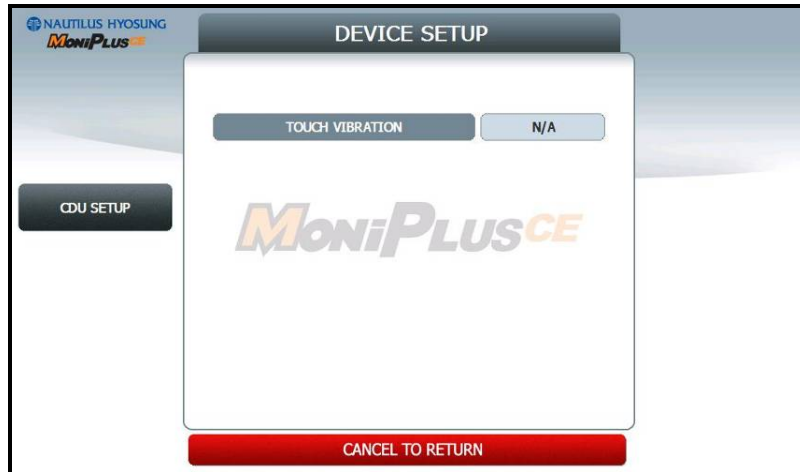

NOTE: When you change CDU Setup Information, contact the service personnel.

5.8.7.1 CDU SETUP

This **CDU SETUP** menu contains **COUNTRY**, **CDU TYPE**, **CASSETTE VOLUME** and **EXECUTE**. Please press each button on this menu to operate the related function..

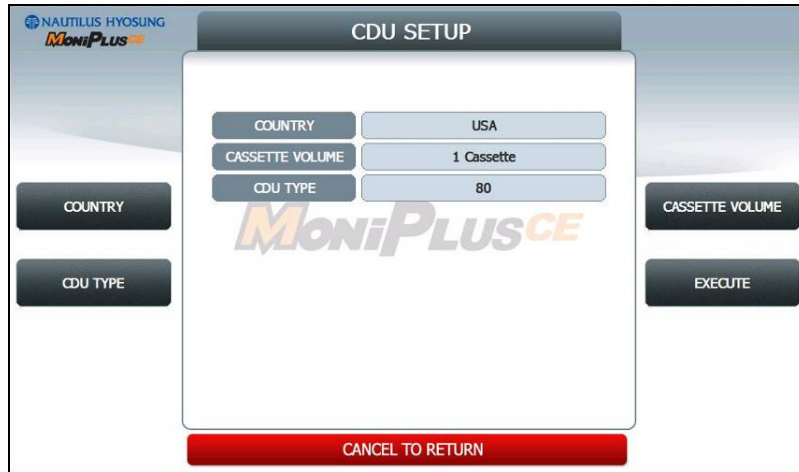

Press the buttons **COUNTRY**, **CDU TYPE** and **CASSETTE VOLUME**. Then the CDU SETUP INFORMATION will be changed.

If you changed the information correctly, press the **EXECUTE** button to **APPLY**.

1) COUNTRY

USA	CANADA	KOREA	CHINA	JAPAN	MEXICO
DEUTSCH	INDONESIA	ENGLAND	TURKEY	ROMANIA	AUSTRALIA
INDIA	TAIWAN	EURO	VIETNAM	UKRAINA	ISRAEL
OTHER					

2) CDU TYPE

00	01	03	0b
41	43	47	80
81			

3) CASSETTE VOLUME

1 CASSETTE	2 CASSETTE	3 CASSETTE	4 CASSETTE
------------	------------	------------	------------

5.8.8 SYSTEM CONTROL

This **SYSTEM CONTROL** menu contains **SOFTWARE UPDATE, REBOOT, BACKUP ALL JOURNAL TO USB, BACKUP JOURNAL BY DATE TO USB, BACKUP LOG TO USB, BACKUP NVRAM, RESTORE NVRAM** and **CLEAR NVRAM**.

Please press each button on this menu to go to next screen or to operate the related function..

And if you want to go back to the previous screen, press the **CANCEL** key.



You can back up a various kinds of journal data and log data you want in this menu. Please make sure that USB drive is connected into USB slot before pressing the button. When **BACKUP ALL JOURNALS TO USB, BACKUP JOURNAL BY DATE TO USB** or **BACKUP LOG TO USB** button is selected, this data will be sent into USB flash drive. When **SOFTWARE UPDATE** is entered, it will change to the screen of **SOFTWARE UPDATE**. This is because Software Update functionality is supported at **SYSTEM CONTROL** menu. When **SYSTEM CONTROL** is submitted the files in USB flash drive will be copied to ATM.

Terminal configuration data is saved at NVRAM, so **BACKUP NVRAM** and **RESTORE NVRAM** button is to use the backup and restore terminal configurations.

NOTE:

- 1) How to update the software, please refer to the Appendix.
- 2) BACKUP NVRAM and RESTORE NVRAM Button is only displayed when security door is opened.

5.8.8.1 REBOOT

If you press the **YES** button, ATM will restart.



5.8.8.2 BACKUP JOURNAL BY DATE TO USB

Input the **START DATE** and **END DATE** using **FROM** and **TO** buttons. And press the **SEARCH** button. Then, the journal date between START DATE and END DATE will be sent to USB drive.

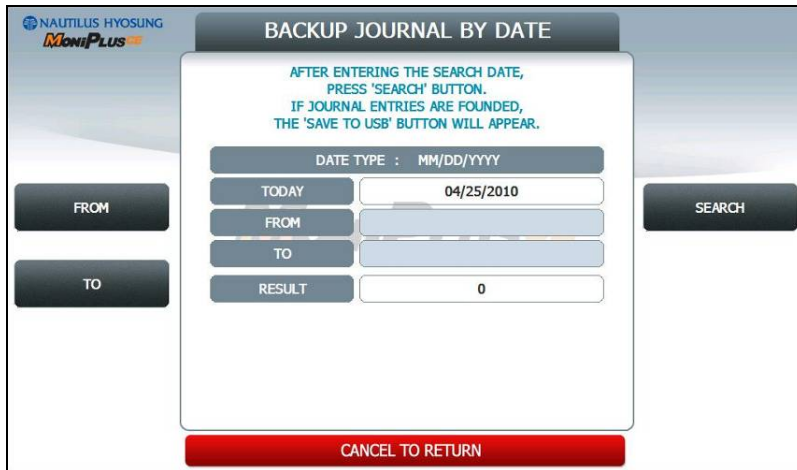

5.8.8.3 CLEAR NVRAM

To clear NVRAM on this ATM, begin by entering the Operator Function Menu using the Master Password. Then enter **SYSTEM SETUP, SYSTEM CONTROL** and **CLEAR NVRAM** in sequence.



1) CLEAR ALL

This will delete all programmed parameters and make all setting information (including passwords) to the default settings. This does NOT include the master keys which are stored in EPP.

2) CLEAR SETTING

This will delete all programmed parameters and make all information (including passwords) to the default settings. This does NOT include the master keys which are stored in EPP, denomination, journal data.

3) CLEAR JOURNAL

This will delete all journal data permanently

4) CLEAR TRANS. SEQUENCE NO.

This function will reset the journal sequence number to <0000>. This may be useful if you switch processing or switch Terminal ID numbers and want to keep new records.

5) CLEAR LOG

This will delete all logs permanently

NOTE: Be careful when using these features (NVRAM clearing) – The initialized data can NOT be recovered.

5.9 HOST SETUP

[DIALUP] This host setup menu contains **KEY MANAGEMENT**, **TELEPHONE NUMBER**, **TERMINAL ID**, **HEALTH CHECK MESSAGE**, **REMOTE MONITOR**, **ROUTING ID** and **AUTO DAY TOTAL**

[TCP/IP] This host setup menu contains **KEY MANAGEMENT**, **HOST ADDRESS**, **TERMINAL ID**, **HEALTH CHECK MESSAGE**, **REMOTE MONITOR**, **ROUTING ID** and **AUTO DAY TOTAL**.

Pressing function key beside menu button goes to next screen. To go back to the previous screen, press the **CANCEL** key in pinpad.

[DIALUP]

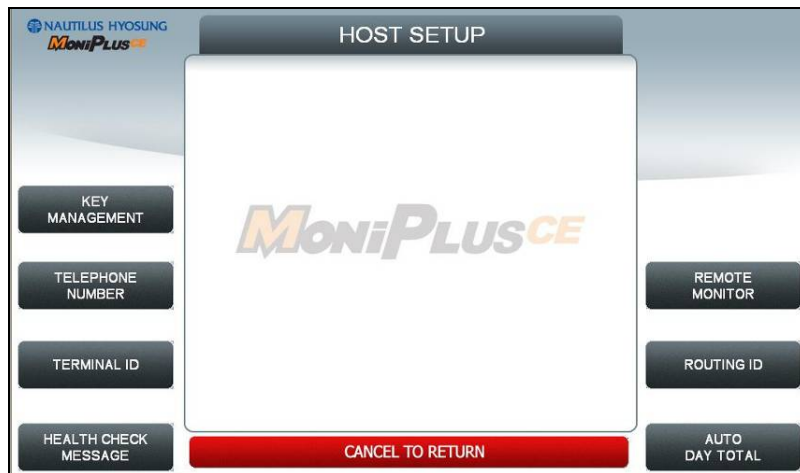

[TCP/IP]



NOTE: **ROUTING ID** is displayed only if the message format is STANDARD1, 2 and EPS

5.9.1 KEY MANAGEMENT

START SCREEN

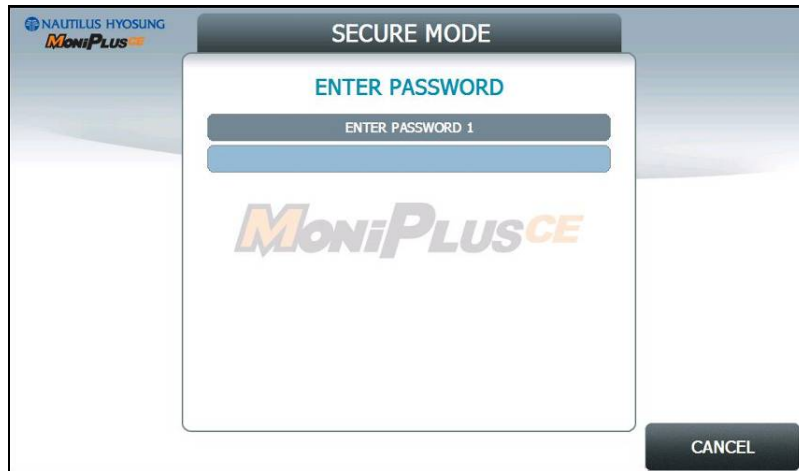

Enter the **PASSWORD 1** and **PASSWORD 2** to execute **KEY MANAGEMENT**.
(Default PASSWORD 1 is '000000'. And default PASSWPRD 2 is '000000' as well)

If you enter **PASSWORD 1** and **PASSWORD 2** correctly, the main screen of KEY MANAGEMENT will be displayed as below.

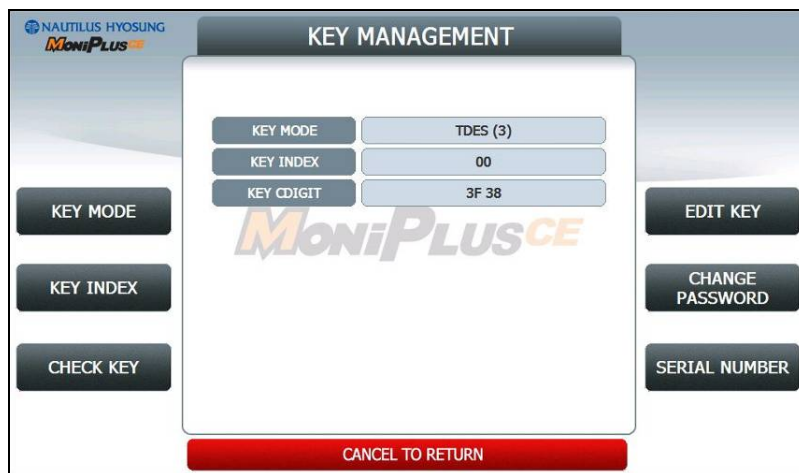

5.9.1.1 KEY MODE

The **KEY MODE** can be changed by pressing **KEY MODE** button. Write down the description here.

There are various kinds of KEY MODE. Those are [DES], [TDES], [DUAL MASTER KEY], [MAC], [TDES, MAC], [TDES, TMAC], [UNIQUE KEY, DES], [UNIQUE KEY, TDES] and [UNIQUE KEY, MAC].

Accessing the KEY INDEX

- 1) Select the **HOST SETUP** in the OPERATOR FUNCTION menu.
- 2) Select the **KEY MANAGEMENT** in the HOST SETUP menu.
- 3) Select the **KEY MODE** in the KEY MANAGEMENT menu. Change the KEY MODE..

5.9.1.2 KEY INDEX

The **KEY INDEX** function is used to set the KEY INDEX. The range is 0 to 15.

You can enter multiple master keys and have to select one of them. For security issue, DP may change key index when they need to change keys.

Accessing the KEY INDEX

- 1) Select the **HOST SETUP** in the OPERATOR FUNCTION menu.
- 2) Select the **KEY MANAGEMENT** in the HOST SETUP menu.
- 3) Select the **KEY INDEX** in the KEY MANAGEMENT menu. Input the KEY INDEX and press ENTER key.

5.9.1.3 CHECK KEY

The CHECK KEY function is used to display the check sum of all injected Keys. The key which is displayed as “_____” means it is in empty state.

The authorized people can verify the injected key(s) with this menu after key injection.

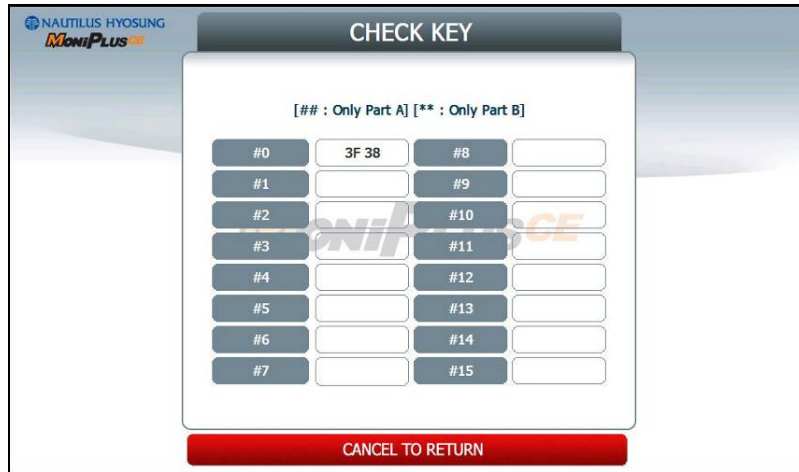

Accessing the CHECK MASTER KEY

- 1) Select the **HOST SETUP** in the OPERATOR FUNCTION menu.
- 2) Select the **KEY MANAGEMENT** in the HOST SETUP menu.
- 3) Select the **CHECK KEY** in the KEY MANAGEMENT menu.
- 4) It will display the check sum of all injected master key.

5.9.1.4 EDIT KEY

The **EDIT KEY** function is used to enter the Master Key, Unique Key and Mac Key.
.The authorized people by bank or DP will enter the Key(s) with this menu.

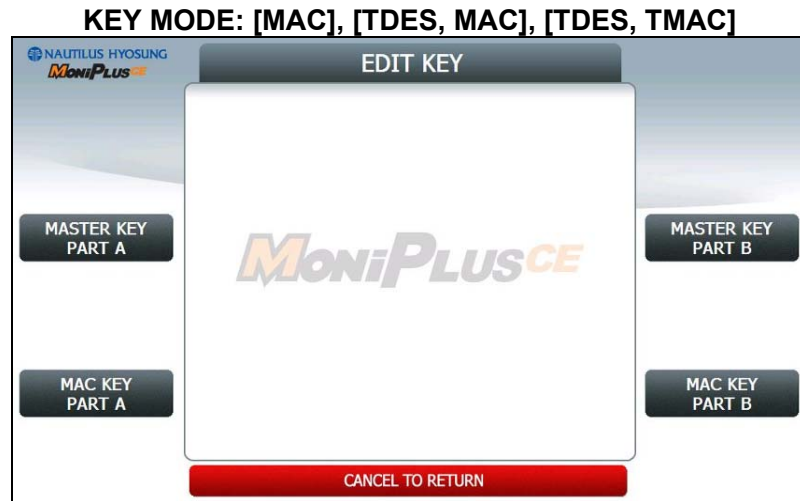



Accessing the EDIT KEY

- 1) Select the **HOST SETUP** in the OPERATOR FUNCTION menu.
- 2) Select the **KEY MANAGEMENT** in the HOST SETUP menu.
- 3) Select the **EDIT KEY** in the KEY MANAGEMENT menu.

A. HOW TO EDIT MASTER KEY

- 1) Press **MASTER KEY PART A** button
- 2) Enter the **MASTER KEY INDEX**.
- 3) Enter the **MASTER KEY PART A**.
- 4) Verify the **MASTER KEY PART A**.
- 5) After inputting the **MASTER KEY PART A**, the **CHECK SUM** will be displayed. Press **ENTER** after confirming the check sum.
- 6) Press **MASTER KEY PART B** button
- 7) Enter the **MASTER KEY INDEX**.
- 8) Enter the **MASTER KEY PART B**
- 9) Verify the **MASTER KEY PART B**.
- 10) After inputting the **MASTER KEY PART B**, the **CHECK SUM** will be displayed. Press **ENTER** after confirming the check sum.

NOTE: You have to input the **SAME KEY INDEX** for **MASTER KEY PART A** and **MASTER KEY PART B**.

B. HOW TO EDIT UNIQUE KEY

- 1) Press **UNIQUE KEY PART A** button
- 2) Enter the **UNIQUE KEY INDEX**.
- 3) Enter the **UNIQUE KEY PART A**.
- 4) Verify the **UNIQUE KEY PART A**.
- 5) After inputting the **UNIQUE KEY PART A**, the **CHECK SUM** will be displayed. Press **ENTER** after confirming the check sum.
- 6) Press **UNIQUE KEY PART B** button
- 7) Enter the **UNIQUE KEY INDEX**.
- 8) Enter the **UNIQUE KEY PART B**
- 9) Verify the **UNIQUE KEY PART B**.
- 10) After inputting the **UNIQUE KEY PART B**, the **CHECK SUM** will be displayed. Press **ENTER** after confirming the check sum.

NOTE: You have to input the **SAME KEY INDEX** for **UNIQUE KEY PART A** and **UNIQUE KEY PART B**.

B. HOW TO EDIT MAC KEY

- 1) Press **MAC KEY PART A** button
- 2) Enter the **MAC KEY INDEX**.
- 3) Enter the **MAC KEY PART A**.
- 4) Verify the **MAC KEY PART A**.
- 5) After inputting the **MAC KEY PART A**, the **CHECK SUM** will be displayed. Press **ENTER** after confirming the check sum.
- 6) Press **MAC KEY PART B** button
- 7) Enter the **MAC KEY INDEX**.
- 8) Enter the **MAC KEY PART B**
- 9) Verify the **MAC KEY PART B**.
- 10) After inputting the **MAC KEY PART B**, the **CHECK SUM** will be displayed. Press **ENTER** after confirming the check sum.

NOTE: You have to input the **SAME KEY INDEX** for **MAC KEY PART A** and **MAC KEY PART B**.

5.9.1.5 SERIAL NUMBER

The SERIAL NUMBER function is used to insert ATM number for RMS.



Accessing the SET MASTER KEY SERIAL NUMBER

- 1) Select the **HOST SETUP** in the OPERATOR FUNCTION menu.
- 2) Select the **KEY MANAGEMENT** in the HOST SETUP menu.
- 3) Select the **SERIAL NUMBER** in the KEY MANAGEMENT menu. And insert serial number.

5.9.2 TELEPHONE NUMBER (Only Dial-Up)

If you press each button on this menu, phone number of host can be input. You can input character, number and special symbol up to 1~20 digits by using '<' or '>'.

This function is used to enter the primary phone number and the back-up phone number of the host. When dialing to host is failure (busy, no answer or etc), ATM switches to other phone number automatically.



5.9.3 HOST ADDRESS

HOST ADDRESS contains **URL EN/DISABLE**, **HOST ADDRESS 1**, **PORT NUMBER 1**, **HOST ADDRESS 2** and **PORT NUMBER 2**.

Press **PORT NUMBER 1** and **PORT NUMBER 2** buttons, and then the values can be input on this screen. These values can be saved by pressing **ENTER** key

HOST ADDRESS 1 and **HOST ADDRESS 2** buttons go to the next page.

To go back to the previous screen, press the **CANCEL** key in pinpad.

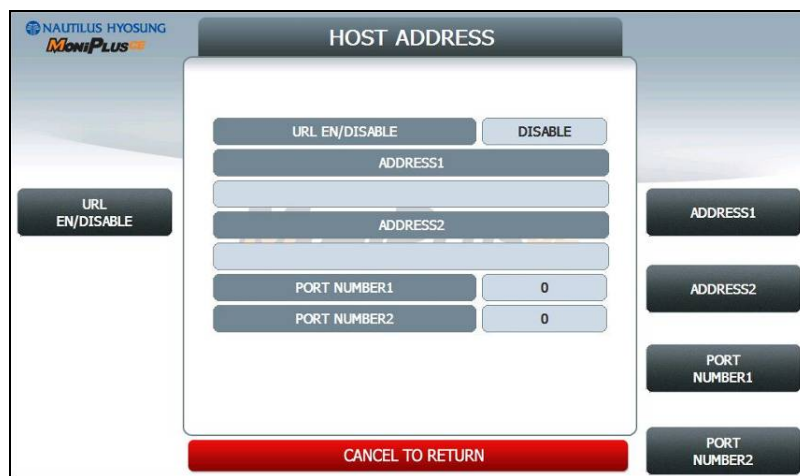

5.9.3.1 HOST ADDRESS 1

The **HOST ADDRESS 1** function is used to edit the host address 1.

Please input the host address 1 in the field and select **OK** button. If it succeeded, “**OPERATION SUCCESSFUL!**” displays.

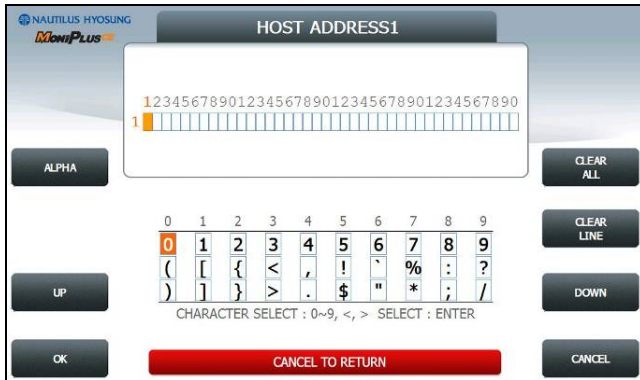

[Function Key Type]



[Touch Type]

5.9.3.2 HOST ADDRESS 2

The **HOST ADDRESS 2** function is used to edit the host address 2.

Please input the host address 2 in the field and select **OK** button. If it succeeded, “**OPERATION SUCCESSFUL!**” displays.

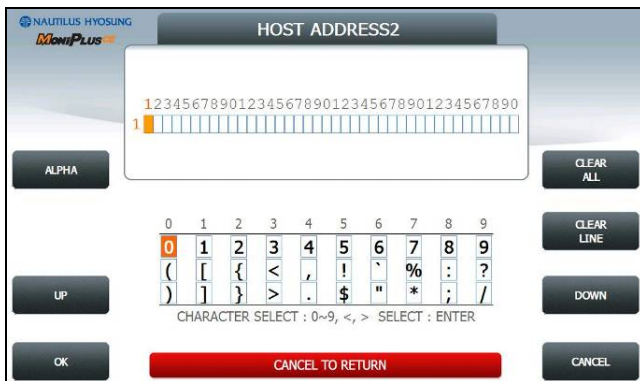

[Function Key Type]

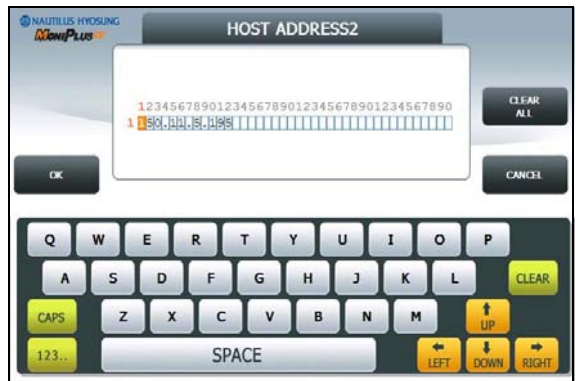

[Touch Type]

5.9.4 TERMINAL ID

The **TERMINAL ID** function is used to edit the terminal id number of ATM.

Please input the terminal id in the field and select **OK** button. If it succeeded, **“OPERATION SUCCESSFUL!”** displays.

Host will identify ATM by looking at terminal ID. Terminal ID will be included in host message and will be printed on the receipt.

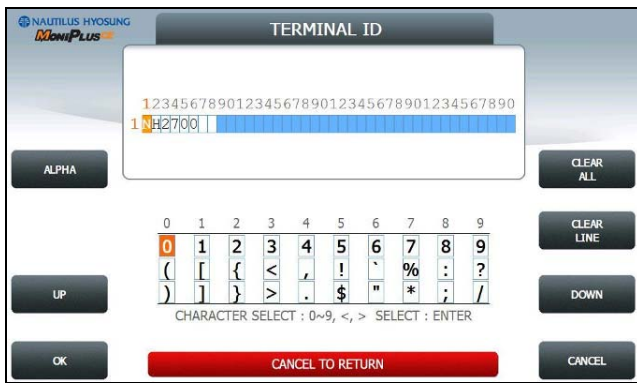

[Function Key Type]



[Touch Type]

5.9.5 HEALTH CHECK MESSAGE

If you press **EN/DISABLE** button, either "ENABLE" or "DISABLE" can be selected. ATM sends its status periodically to the host when **HOST SEND** is set up to "Enable". The interval is dependent on "**SEND INTERVAL**".

If you press **SEND INTERVAL** button, the value of SEND INTERVAL can be adjusted. (1 ~ 24). This value is saved by pressing **ENTER** button.



5.9.6 REMOTE MONITOR

- Display which is to set the information for using Remote Management System (RMS)

- 1) **RMS EN/DISABLE** function is used to connect to the RMS mode to enable or to disable. The default option is "ENABLE".
- 2) **RMS STATUS SEND EN/DISABLE** function is used to send the status message to RMS in enable or in disable.
- 3) The **RMS PASSWORD** function is used to set the RMS password to connect to ATM from RMS.

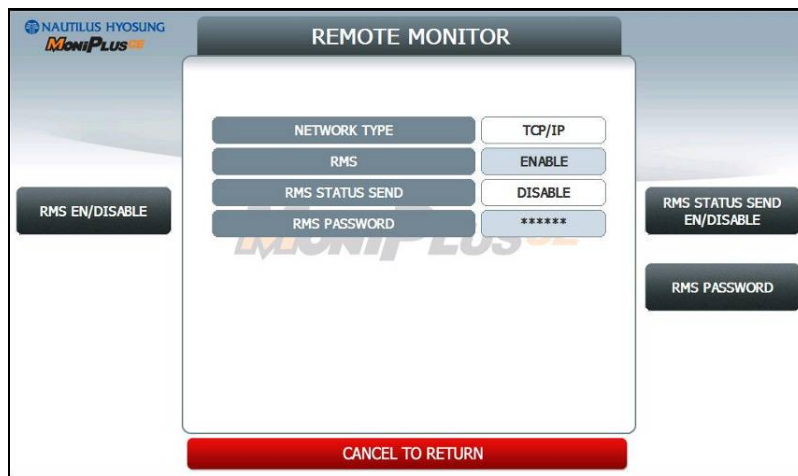

5.9.6.1 RMS EN/DISABLE

[DIALUP] Display which is to set the **RMS RING COUNT** for the reception on standby of ATM.

[TCP/IP] Display which is to set the **RMS LISTENING PORT** for the reception on standby of ATM.

Default port is 5555

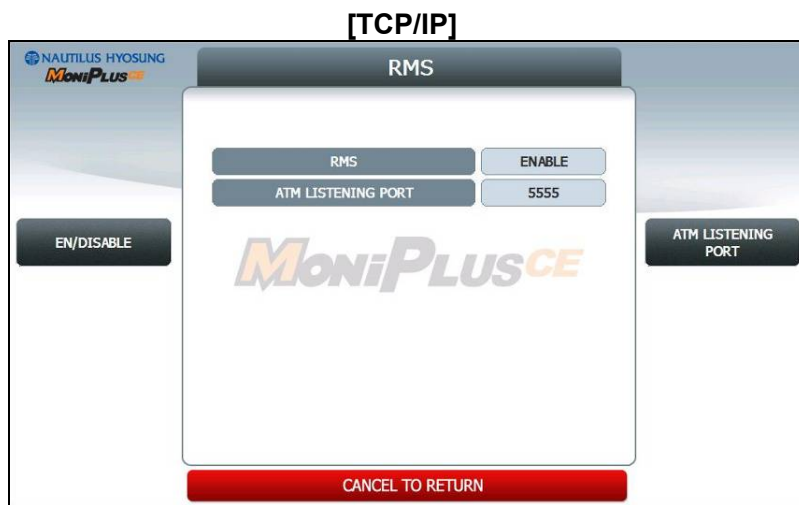
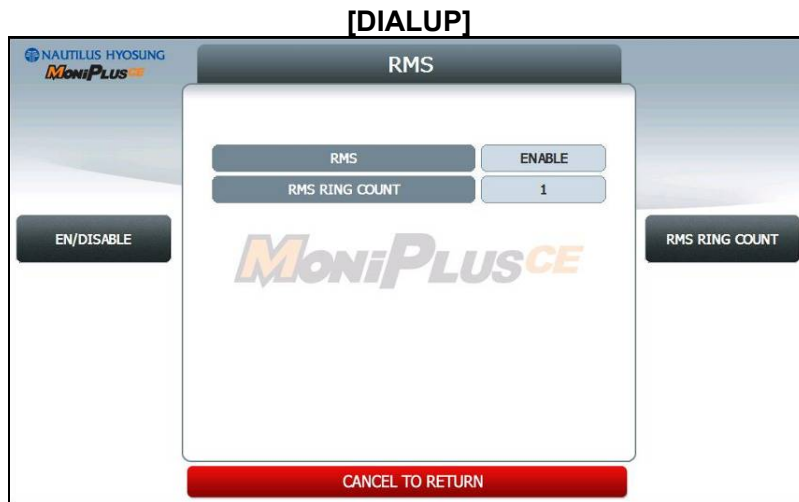

5.9.6.2 RMS STATUS SEND EN/DISABLE

- Display which is to set the function to transfer STATUS to RMS from ATM.



1) RMS STATUS SEND

- Display whether RMS STATUS SEND function is ENABLE or DISABLE.
- Set the value using **EN/DISABLE** button.

2) INTERVAL

- Display "RMS STATUS SEND" cycle (unit: hours)
- Set the value using **INTERVAL** button. (Input the number from 1 to 24.)

3) PHONE 1, PHONE 2

- Display RMS TELEPHONE NUMBER for RMS COMMUNICATION
- Set the values using **PHONE NUMBER 1** and **PHONE NUMBER 2**. (Input the number up to 20.)

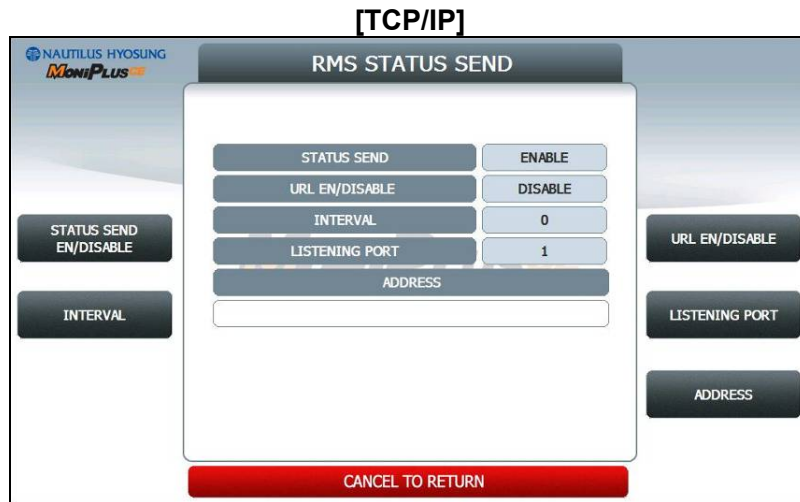

1) RMS STATUS SEND

- Display whether RMS STATUS SEND function is enabled or not.
- Set the value using **EN/DISABLE** button.

2) RMS INTERVAL

- Display “RMS STATUS SEND” cycle (unit: hours)
- Set the value using **INTERVAL** button. (Input the number from 1 to 24.)

3) URL EN/DISABLE

- Display whether to use URL or IP ADDRESS. If the value is ENABLE, that means ATM uses URL ADDRESS.
- Set the value using **URL EN/DISABLE** button.

4) RMS ADDRESS

- Display “RMS ADDRESS”.
- Set the value using **RMS ADDRESS** button. If you press this button, It goes to next screen.

5) RMS LISTENNING PORT

- Display “RMS LISTENNING PORT”.
- Set the value using **RMS LISTENNING PORT** button. (Input the number from 0 to 65535)
- Default port is 9999

5.9.6.2.1 RMS ADDRESS

The **RMS ADDRESS** function is used to edit the rms address.

Please input the rms address in the field and select **OK** button. If it succeeded, “**OPERATION SUCCESSFUL!**” displays

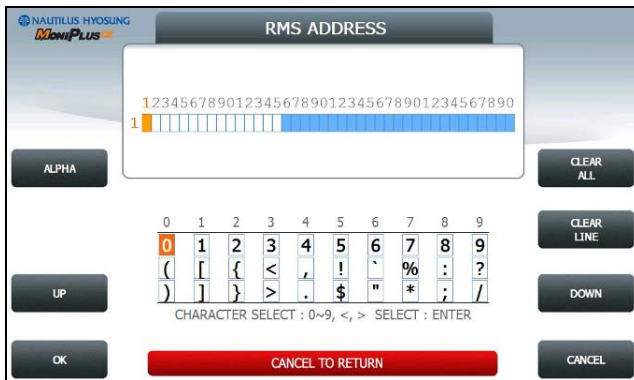

[Function Key Type]

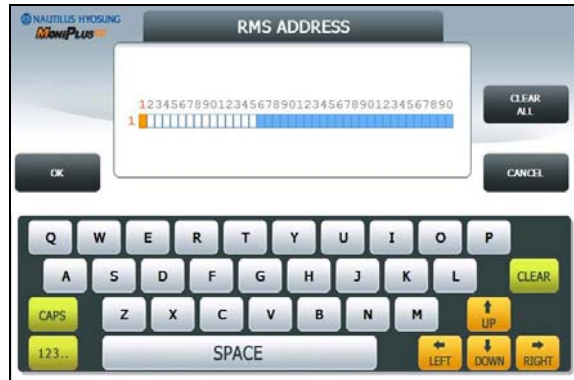

[Touch Type]

5.9.7 ROUTING ID

The **ROUTING ID** function is used to edit the Routing ID Number of ATM. Routing ID refers to the Bank ID. This field is contained to STANDARD 1, STANDARD 2 and EPS format.

Please input the routing id in the field and select **OK** button. If it succeeded, **“OPERATION SUCCESSFUL!”** displays.

To go back to the previous screen, press the **CANCEL** key in pinpad.

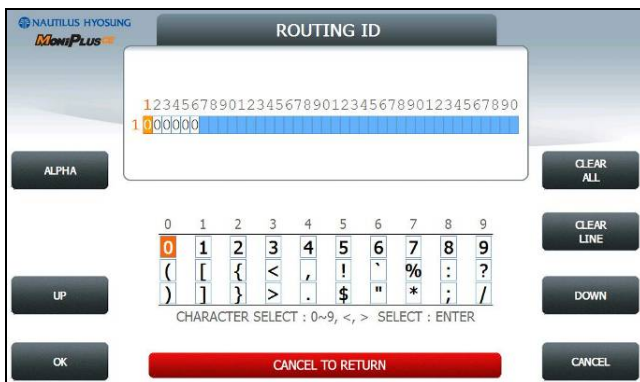

[Function Key Type]



[Touch Type]

5.9.8 AUTO DAY TOTAL

AUTO DAY TOTAL feature allows ATM to complete a Day Total operation (Without Actually closing out the machine) at a predetermined time each day. This is useful if you are doing accounting of your ATM on a day-to-day basis. Your processor cuts off its transactions each day at a set time. By enabling Auto Day Total at the same time, your day’s balance should match the host. This information will appear as a journal record so, you will need to access your journal to print or view the totals.

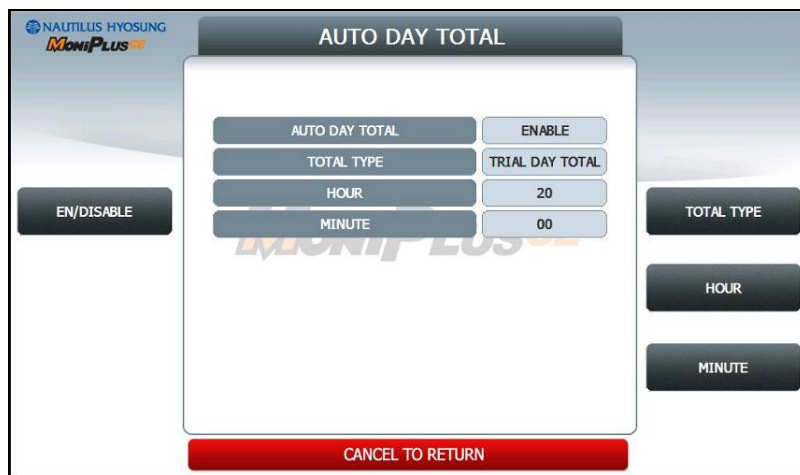

1) EN/DISABLE

- Display whether AUTO DAY TOTAL function is enabled or not.
- Set the value using **EN/DISABLE** button.

2) TOTAL TYPE

- Display AUTO DAY TOTAL TYPE
 - DAY TOTAL: ATM sends total to your processor then initialize total
 - TRIAL DAY TOTAL: ATM sends total to your processor
- Set the value using **TOTAL TYPE** button.

3) HOUR / MINUTE

- Display the time for ATM to total itself
- Set the value using **HOUR** and **MINUTE** button.

5.10 TRANSACTION SETUP

This transaction setup menu contains **DISPENSE LIMIT**, **LOW CURRENCY CHECK EN/DISABLE**, **FAST CASH** and **DENOMINATION**. By pressing each button, you can execute each function or enter each sub menu. To go back to the previous screen, press the **CANCEL** key in pinpad.

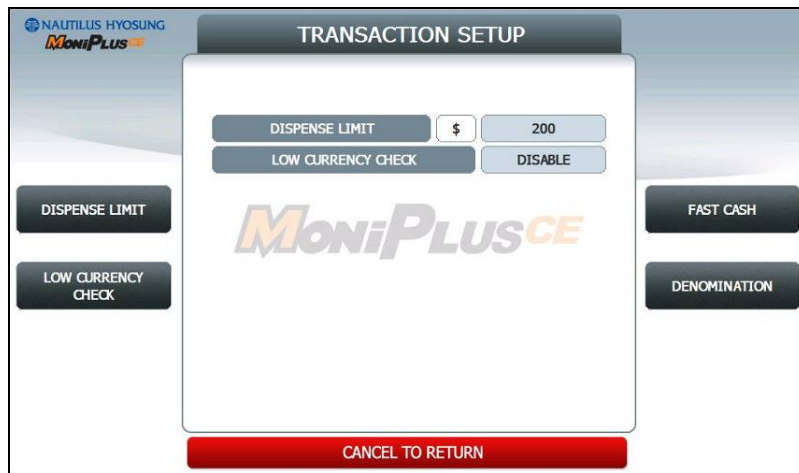

1) DISPENSE LIMIT

This function is used to set the maximum amount of notes that can be dispensed per transaction. The amount must be a multiple of denomination. And the maximum dispensed count a transaction must not be over a total of 40 notes.

(eg. You can't input over \$4000 on DISPENSE LIMIT if max denomination is \$100 on ATM.)

2) LOW CURRENCY CHECK EN/DISABLE

This function is used to set the detection of cassette low level (100 bills or less). If enabled, hardware will report the low condition to the software and the machine will go to "OUT OF SERVICE" mode under low note condition.

5.10.1 FAST CASH

FAST CASH function is used to set the cash amount which is to be displayed on the FAST CASH screen. The maximum amount must be less than the **DISPENSE LIMIT**.

You can set 6 kinds of values which are frequently requested by customer using this function. By using this function, customers withdraw the money more easily.



5.10.2 DENOMINATION

This function is used to set the denomination of note to be set in the cassette. Pressing function key beside menu button selects the cassette to set the denomination of note. Input the note value you want and press the **ENTER** key in the pinpad. If you completed the all cassette setting, you have to press **APPLY** button to effect the value changes.

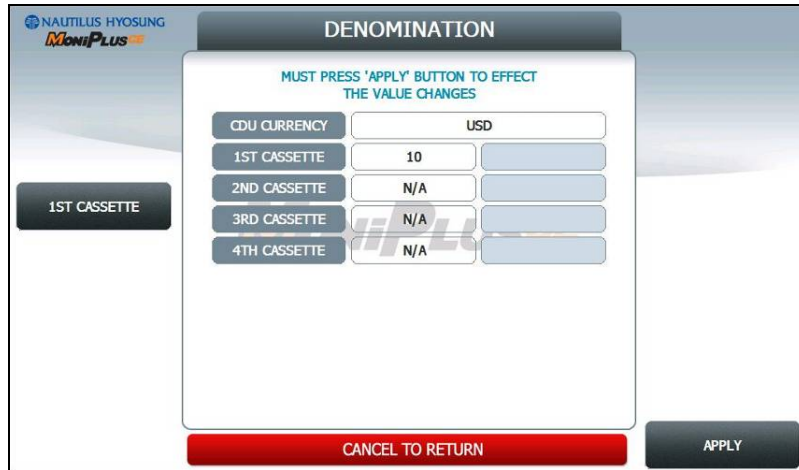

5.11 SITE MAP

This site map shows the structure of the operator menu tree to aid in searching menu. In case of touch type, if you press each menu **SETTLEMENT**, **JOURNAL**, **REPORT**, **DIAGNOSTICS**, **CUSTOMER SETUP**, **SYSTEM SETUP**, **HOST SETUP** or **TRANSACTION SETUP**, then it will enter each sub-menu.



5.12 QUICK REPLENISH

This menu provides convenience for replenishing note at once. This menu consists of **DAY TOTAL**, **CASSETTE TOTAL**, **ADD CASH** and **RESULT**.

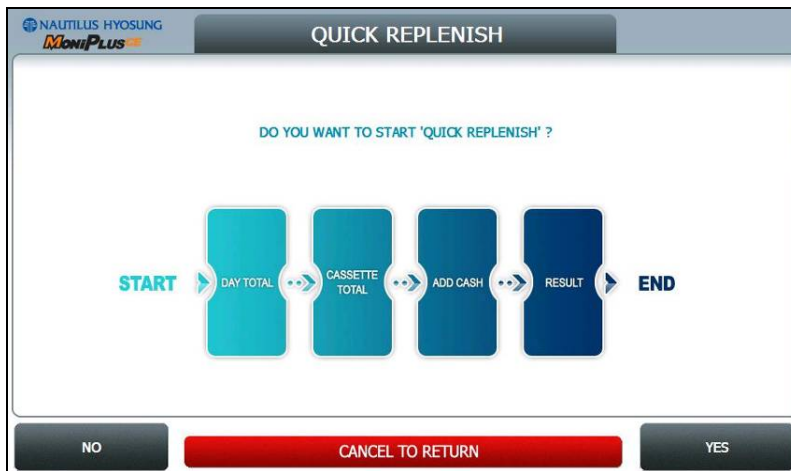

If you press **YES** button, the QUICK REPLENISH will start.

5.12.1 DAY TOTAL / CASSETTE TOTAL

It will perform **DAY TOTAL** and **CASSETTE TOTAL** first.

- 1) **DAY TOTAL** : Do settlement with host. After settlement, clear transaction information.

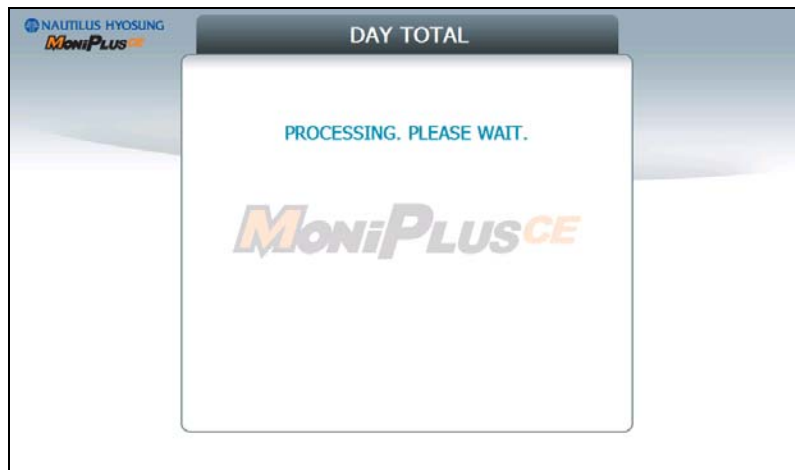

- 2) **CASSETTE TOTAL** : Clear note count information.

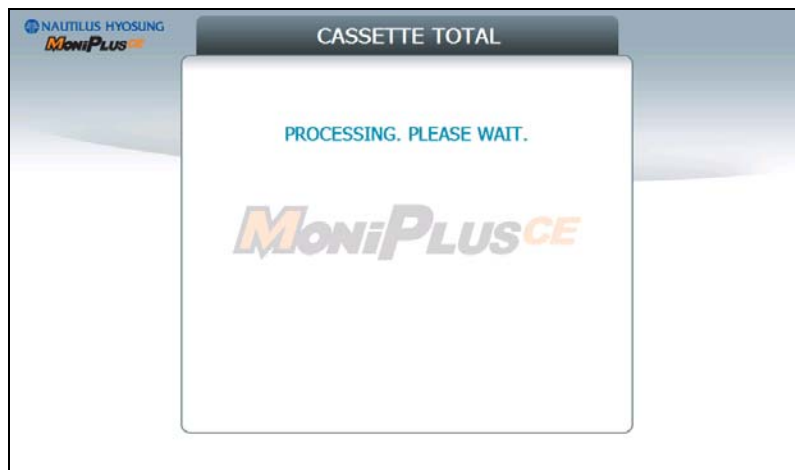

5.12.2 ADD CASH

After performing **DAY TOTAL** and **CASSETTE TOTAL**, **ADD CASH** screen will be shown as below. By pressing button on this menu, you can select cassette to add note count. (Cassette numbers are designated from top to bottom). Input the note count you want to add and press the **ENTER** key in the pinpad. If you completed the all cassettes, you have to press **APPLY** button to effect the value changes.

NOTE: The total note count you enter must not exceed the maximum note count.
(Max. note count : 2,000/CST)

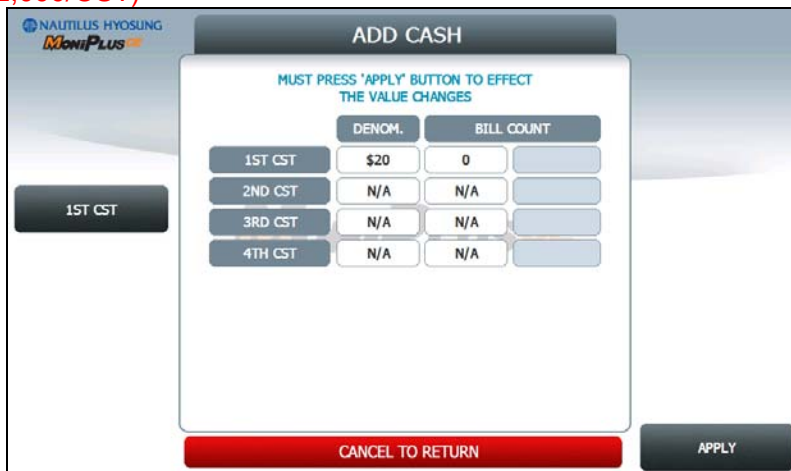

5.12.3 RESULT

After performing **QUICK REPLENISH**, the result will be shown as below.



5.13 QUICK CONFIGURATION

This menu provides convenience to configure **ATM Setup Information** at once. This menu consists of **NETWORK SETUP**, **MESSAGE FORMAT SETUP**, **TERMINAL ID SETUP**, **PASSWORD SETUP** and **RESULT CONFIGURATION**.



5.13.1 TCP/IP

This chapter shows how to configure for TCP/IP Setup Information.

5.13.1.1 COMMUNICATION

This is to set up a type of line to communicate with Host. Select **TCP/IP**. In case of setting up TCP/IP, communicate with host using LAN.

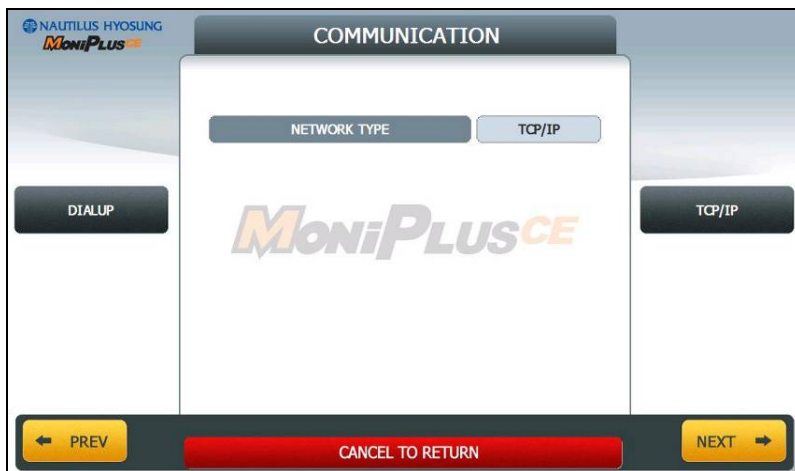

5.13.1.2 TCP/IP TYPE

In case of supporting **TCP/IP**, this is providing a function setting up communication flow to use when communicating with host. In this menu, you can change **TCP/IP TYPE** and can decide whether 'ENABLE' or 'DISABLE' about **SSL OPTION**. There are three kind of **TCP/IP** type in this TCP/IP COMMUNICATION menu

(**STANDARD TCP/IP, VISA FRAMED TCP/IP, and ACK CONTROLLED TCP/IP**).

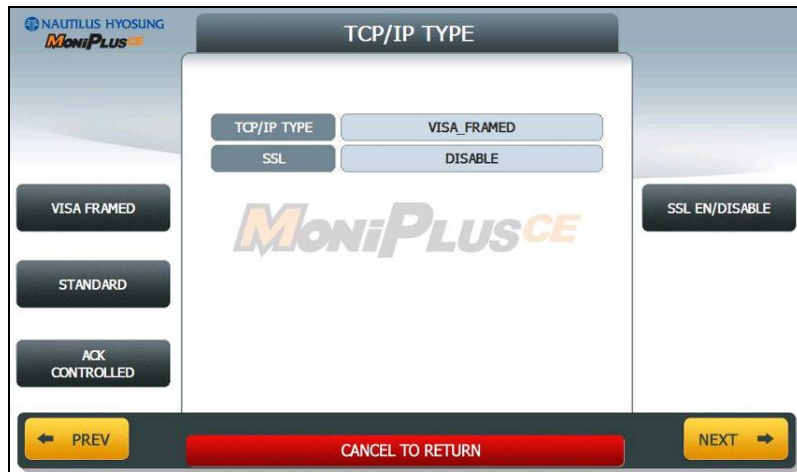

NOTE: When you press **NEXT** button, if you configured TCP/IP TYPE to VISA FRAMED, then it goes to Section No 5.13.1.3. If not, then it goes to Section No. 5.13.1.4.

5.13.1.3 EOT/ENQ OPTION

EOT/ENQ OPTION contains GENERAL, EOT OPTIONAL, NO EOT REQUIRED and NO ENQ REQUIRED functions. You can select one of these options.

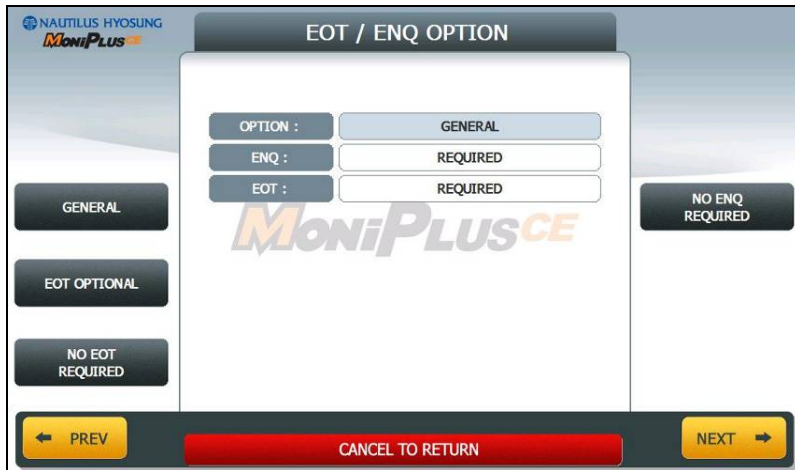

5.13.1.4 HOST ADDRESS

HOST ADDRESS contains URL EN/DISABLE, HOST ADDRESS 1 and PORT NUMBER 1.

Press PORT NUMBER 1 button, and then the values can be input on this screen. These values can be saved by pressing ENTER key. The HOST ADDRESS 1 button is used to edit the host address 1. Please input the host address 1 in the field.

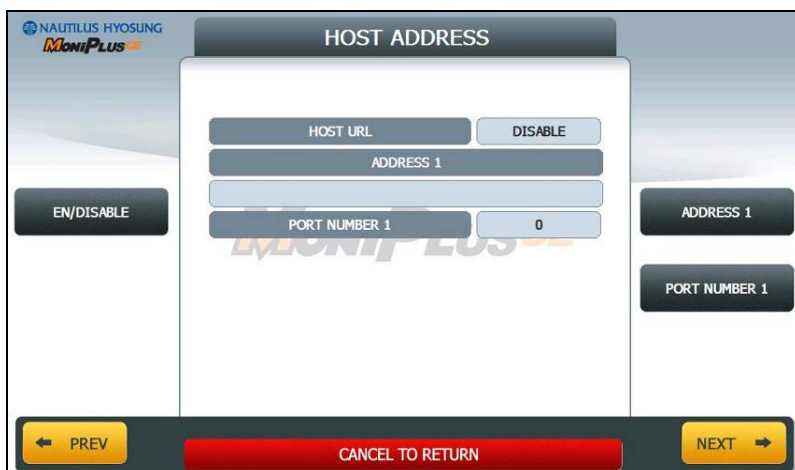

5.13.1.5 TERMINAL DHCP

If **DHCP** value is **ENABLE**, ATM uses **DYNAMIC IP** to connect to host. Otherwise, ATM uses **STATIC IP**. If you configure DHCP value to **DISABLE** and press **NEXT**, it goes to **TERMINAL IP SETUP** Screen.

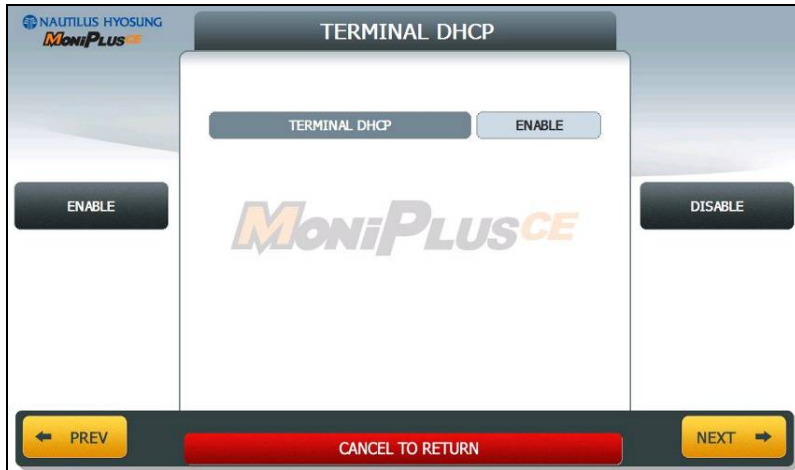

NOTE: When you press **NEXT** button, if you configured DHCP to **DISABLE**, then it goes to Section No 5.13.1.6. If not, then it goes to Section No. 5.13.1.7.

5.13.1.6 TERMINAL IP

Set up **STATIC IP** using **IP ADDRESS**, **SUBNET MASK**, **GATEWAY** and **DNS** buttons. It is able to input up to 15 units such as **XXX.XXX.XXX.XXX**



5.13.1.7 MESSAGE FORMAT

This menu sets up message format to use during communicating with Host.

You can select one of message type to communicate with a data processing company or bank in this menu (**STANDARD1**, **STANDARD2**, **STANDARD3** and **EPS**).

STANDARD 1 is a HYOSUNG message type and **STANDARD 2** is a CSP200 message type, **STANDARD 3** is Triton 9600 message type and **EPS** is an extended CSP200 message type.

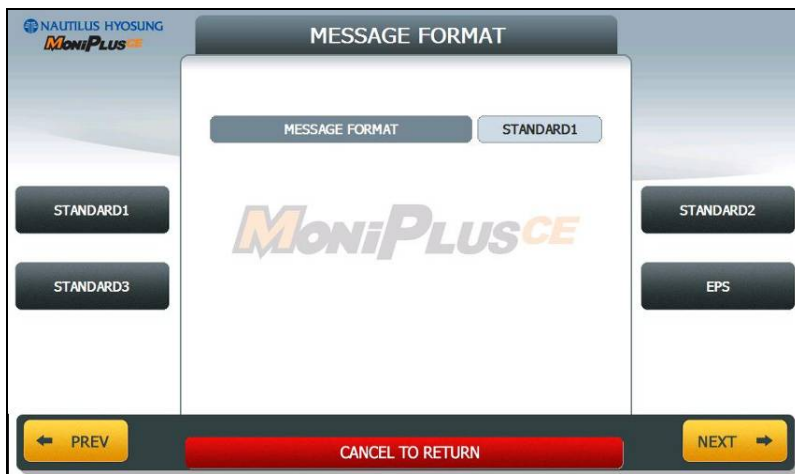

NOTE: When you press **NEXT** button, if you configured MESSAGE FORMAT to STANDARD 3, then it goes to Section No 5.13.1.9. If not, then it goes to Section No. 5.13.1.8.

5.13.1.8 ROUTING ID

The **ROUTING ID** function is used to edit the Routing ID Number of ATM. Routing ID refers to the Bank ID. This field is contained to STANDARD 1, STANDARD 2 and EPS format.

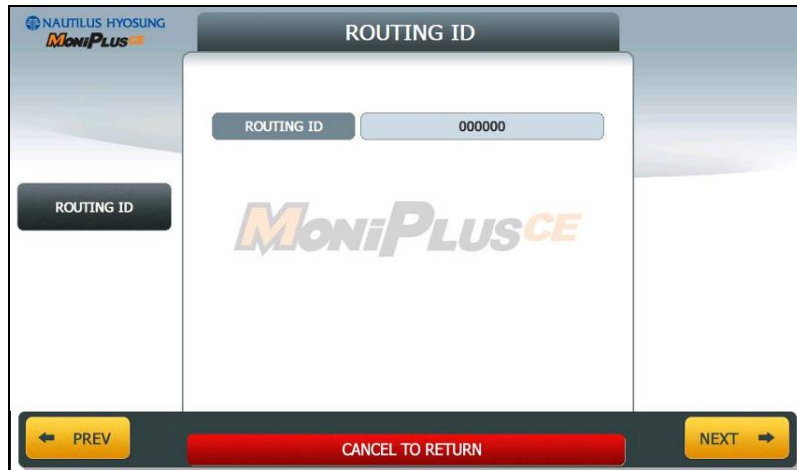

NOTE: When you press **NEXT** button, it goes to Section No 5.13.1.10.

5.13.1.9 STANDARD3 OPTION

STANDARD 3 OPTION contains **STATUS MONITORING EN/DISABLE**, **COMMUNICATION HEADER**, **COMMUNICATION ID** and **CRC EN/DISABLE**.

In case of **COMMUNICATION HEADER** is enabled, **CRC EN/DISABLE** option can be configured.



STANDARD 3 OPTION function is used to get the additional information when Triton message is selected.

- 1) **STATUS MONITORING** function is to decide whether status monitoring field in message is sent or not.
- 2) **COMMUNICATION HEADER** function is to decide whether communication header in message is included or not.
- 3) **COMMUNICATION ID** function is able to save the **COMMUNICATION ID**.
The **COMMUNICATION ID** has to be set if using the **COMMUNICATION HEADER** function.
- 4) **CRC(Cyclic Redundancy Checking) OPTION** function is to set up whether CRC is used or not during communication with host.

5.13.1.10 TERMINAL ID

The **TERMINAL ID** function is used to edit the terminal id number of ATM.

Host will identify ATM by looking at terminal ID. Terminal ID will be included in host message and will be printed on the receipt.



5.13.1.11 PASSWORD SETUP (MASTER PASSWORD)

This menu enables you to change current master password as new one. To change the current password, you should input the proper one in current password field. The factory default value of master password is "555555".



5.13.1.12 RESULT

After performing **QUICK CONFIGURATION**, the result will be shown as below.

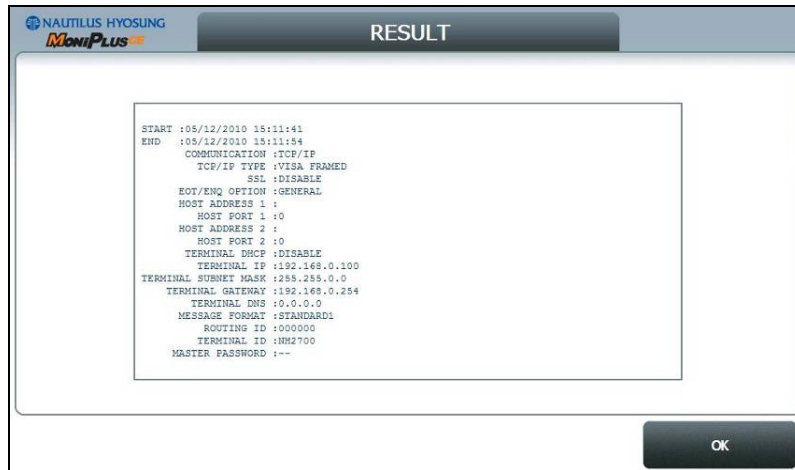

5.13.2 DIAL UP

This chapter shows how to configure for DIALUP Setup Information.

5.13.2.1 COMMUNICATION

This is to set up a type of line to communicate with Host. Select **DIALUP**. In case of setting up DIALUP, communicate with host using modem.

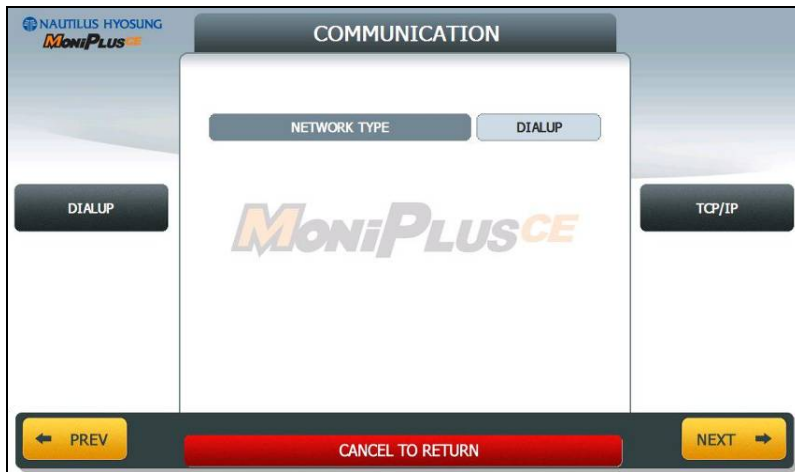

5.13.2.2 EOT/ENQ OPTION

EOT/ENQ OPTION contains **GENERAL**, **EOT OPTIONAL**, **NO EOT REQUIRED** and **NO ENQ REQUIRED** functions. You can select one of these options.

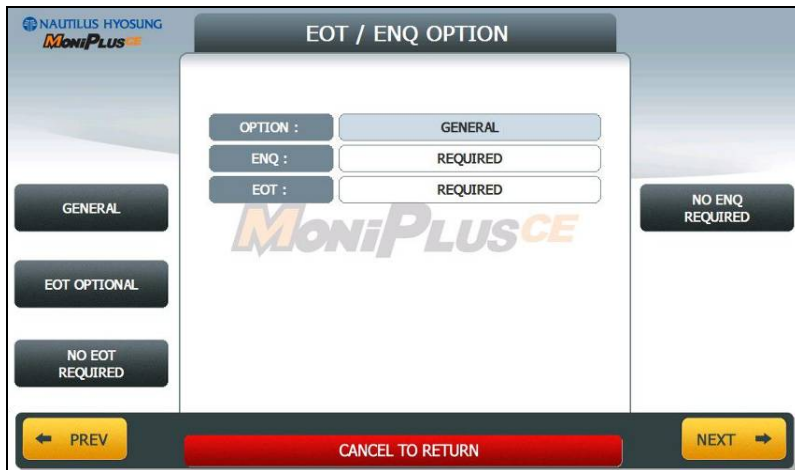

5.13.2.3 TELEPHONE NUMBER (HOST PHONE 1)

If you press each button on this menu, phone number of host can be input. You can input character, number and special symbol up to 1~20 digits by using '<' or '>'.



5.13.2.4 MESSAGE FORMAT

This menu sets up message format to use during communicating with Host.

You can select one of message type to communicate with a data processing company or bank in this menu (**STANDARD1**, **STANDARD2**, **STANDARD3** and **EPS**).

STANDARD 1 is a HYOSUNG message type and **STANDARD 2** is a CSP200 message type, **STANDARD 3** is Triton 9600 message type and **EPS** is an extended CSP200 message type.

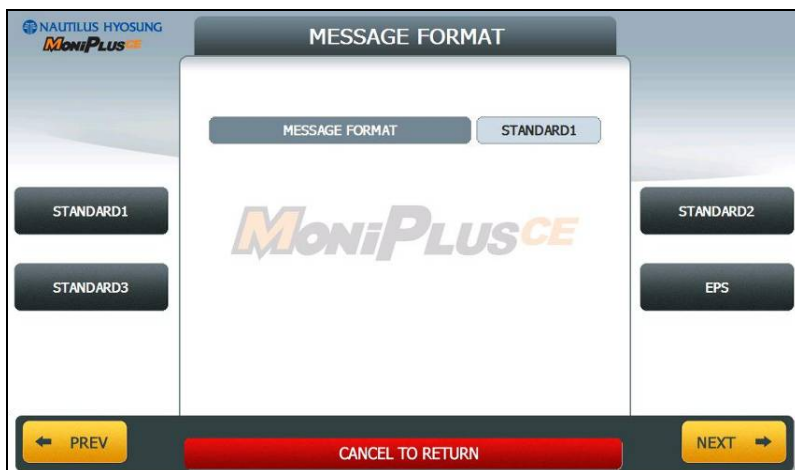

NOTE: When you press **NEXT** button, if you configured MESSAGE FORMAT to **STANDARD 3**, then it goes to Section No 5.13.2.6. If not, then it goes to Section No. 5.13.2.5.

5.13.2.5 ROUTING ID

The **ROUTING ID** function is used to edit the Routing ID Number of ATM. Routing ID refers to the Bank ID. This field is contained to STANDARD 1, STANDARD 2 and EPS format.

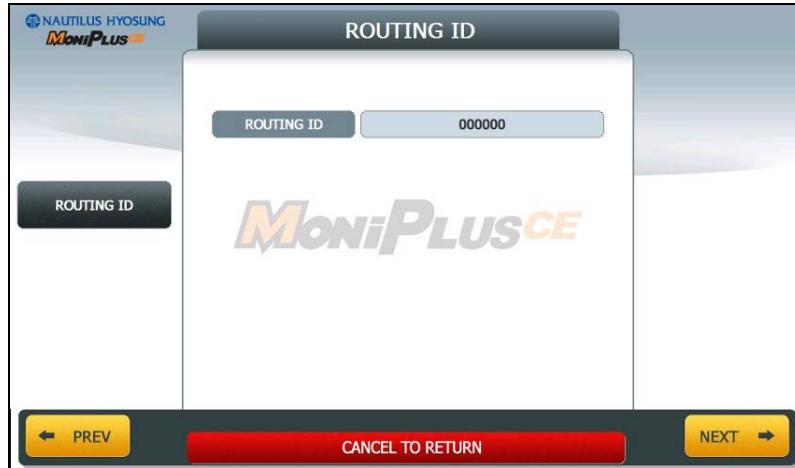

NOTE: When you press **NEXT** button, it goes to Section No 5.13.2.7.

5.13.2.6 STANDARD3 OPTION

STANDARD 3 OPTION contains **STATUS MONITORING EN/DISABLE**, **COMMUNICATION HEADER**, **COMMUNICATION ID** and **CRC EN/DISABLE**.

In case of **COMMUNICATION HEADER** is enabled, **CRC EN/DISABLE** option can be configured.

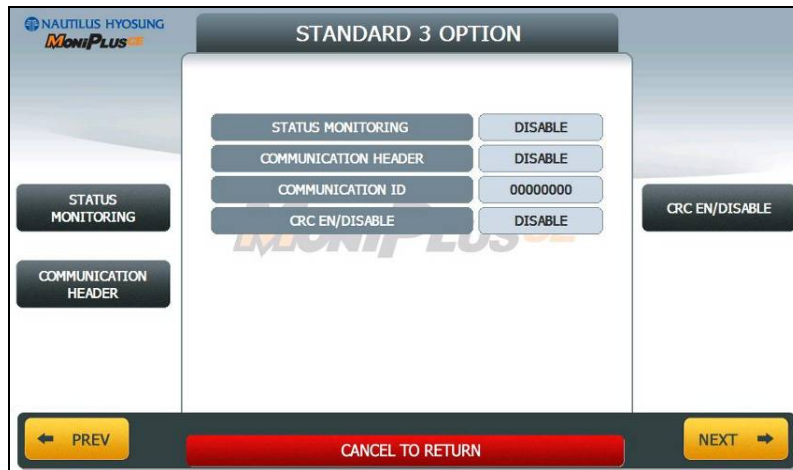

STANDARD 3 OPTION function is used to get the additional information when Triton message is selected.

- 1) **STATUS MONITORING** function is to decide whether status monitoring field in message is sent or not.
- 2) **COMMUNICATION HEADER** function is to decide whether communication header in message is included or not.
- 3) **COMMUNICATION ID** function is able to save the **COMMUNICATION ID**.
The **COMMUNICATION ID** has to be set if using the **COMMUNICATION HEADER** function.
- 4) **CRC(Cyclic Redundancy Checking) OPTION** function is to set up whether CRC is used or not during communication with host.

5.13.2.7 TERMINAL ID

The **TERMINAL ID** function is used to edit the terminal id number of ATM.

Host will identify ATM by looking at terminal ID. Terminal ID will be included in host message and will be printed on the receipt.



5.13.2.8 PASSWORD SETUP (MASTER PASSWORD)

This menu enables you to change current master password as new one. To change the current password, you should input the proper one in current password field. The factory default value of master password is "555555".



5.13.2.9 RESULT

After performing **QUICK CONFIGURATION**, the result will be shown as below.

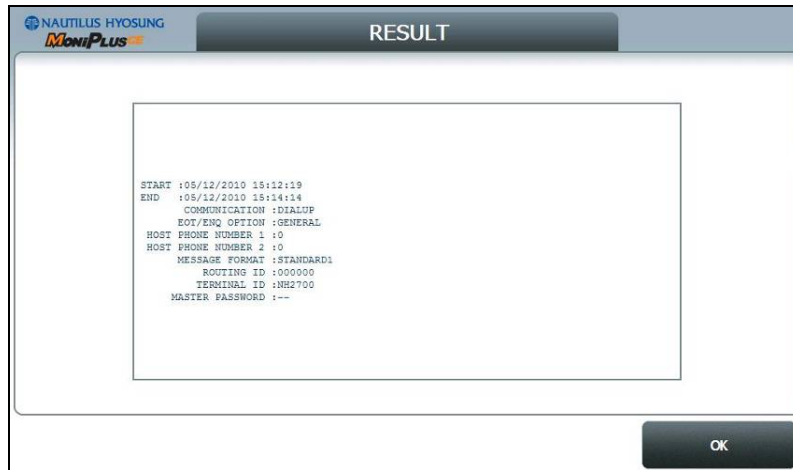

Chapter 6. Installation

6. Installation

6.1 Installation Information

Installation condition and space

Following conditions should be met before installing equipment.

1. Temperature should be between 5 ~ 40°C [41~104°F] (operating), -10 ~ 60°C [14~140°F] (storage).
2. Relative humidity should be between 25~85% (operating) / 10~90% (storage)
3. Avoid locations where intense direct light is reflected off the LCD screen.
4. Avoid locations where strong static electricity can occur.
5. Avoid placing the product next to equipment that produces electromagnetic waves. It could interfere with data transfer.
6. The floor must allow easy wheelchair access from the front or the side.
7. Space required for servicing the machine should be considered before installation.

Tools required for installation

In order to move the machine and place it in a proper location, you need to get help of professionals trained in moving heavy equipment.

Following tools are needed to install the machine.

- Wire cutter
- Lifter
- Screw driver (Flat, Phillips)
- Wrench (Spanner)
- Leveling tool

6.2 System Installation

Unpacking

1. Unpack the machine on top of the palette.
2. Cut the straps that are fastened around the box with a knife.
(Be careful when cutting the straps.)
3. Use an appropriate tool to remove the nails from the palette.
4. Remove the lid, and then box from the top. Do not discard the packaging materials until you have verified any shipping damage claim. Contact your distributor immediately if you see any shipping damage. Store the box in a safe place to re-use or discard of appropriately.
5. Verify the contents carefully with the packing list to be sure all items listed are included. Notify your distributor of any shortages.
6. If only the palette needs to be removed, lift the whole machine from the bottom and set it aside.

Physical Installation

To install this ATM, perform the following steps.

1. Place the “Anchor bolts locate sheet” at the place where the machine is to be installed. (refer to Fig. 6.1)
2. Place the system on a flat surface.
Be careful when opening the top or bottom of the machine because it can be off balance
3. Place the Anchor nuts into the ground according to the anchor bolts locate sheet.
(4 places)
4. Place this ATM on top of the sheet.
5. Open the Security cover with the key provided.
6. Using the supplied combination (factory preset at 1-2-3-4-5-6 or 50-25-50) open the Security Door. This combination should be changed as soon as possible. Refer to Chapter 4 for instructions on changing the lock combination.
7. After the anchor nuts are in place according to the anchor holes on the bottom of this ATM, tighten the anchor bolts tightly. (refer to Fig.6.1)

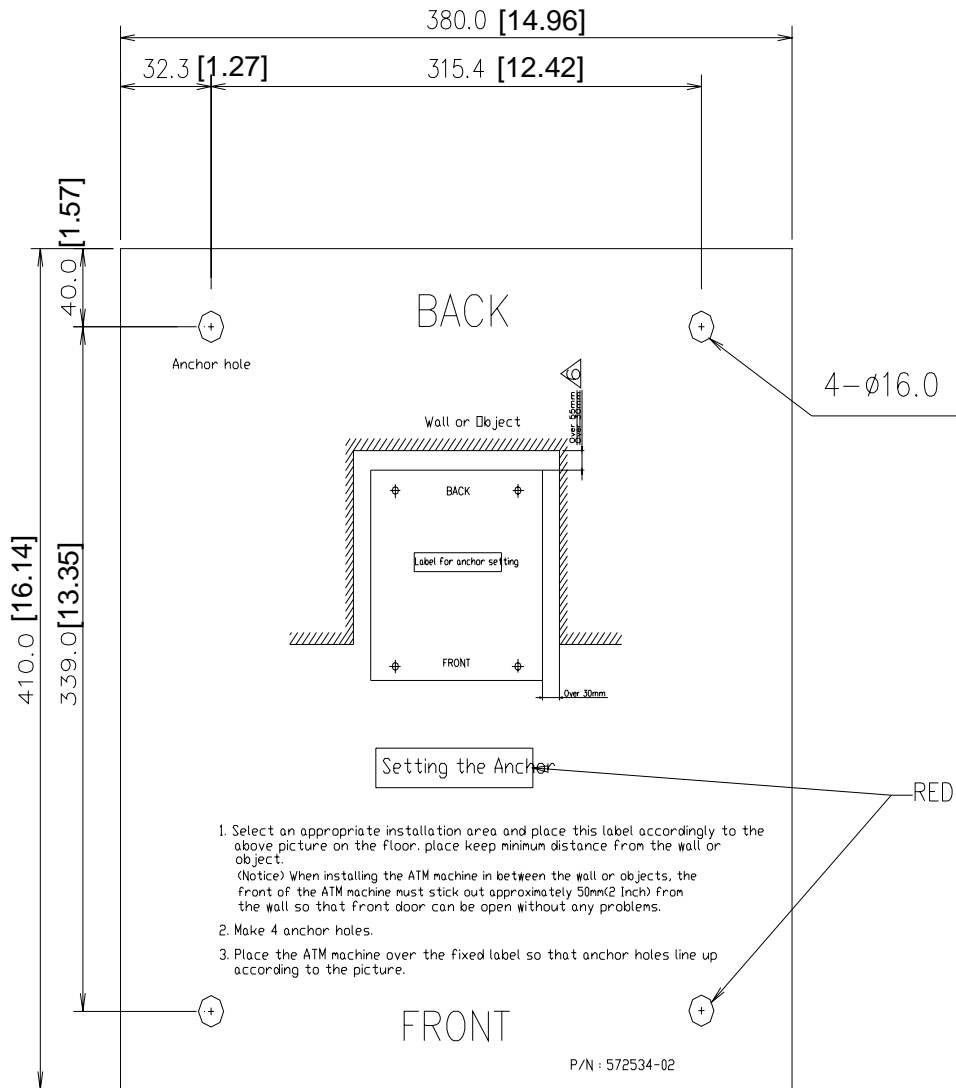

Fig. 6.1 Anchor diagram of this ATM

NOTE: All the unit in the dimension is mm and the unit in the parenthesis is inch.

Anchor Setting

1. Select an appropriate installation area and place this label accordingly to the above picture on the floor. Place keep minimum distance from the wall or object.
(Notice) When you install ATM between the wall and the object, the front of ATM must stick out approximately 50mm [2 inch] from the wall so that front door can be opened without any problems.
2. Make 4 anchor holes.
3. Place ATM over the fixed label so that anchor holes line up according to the picture.

Installation and Service Clearance

Following diagram is describing the areas required for installing and servicing this ATM.

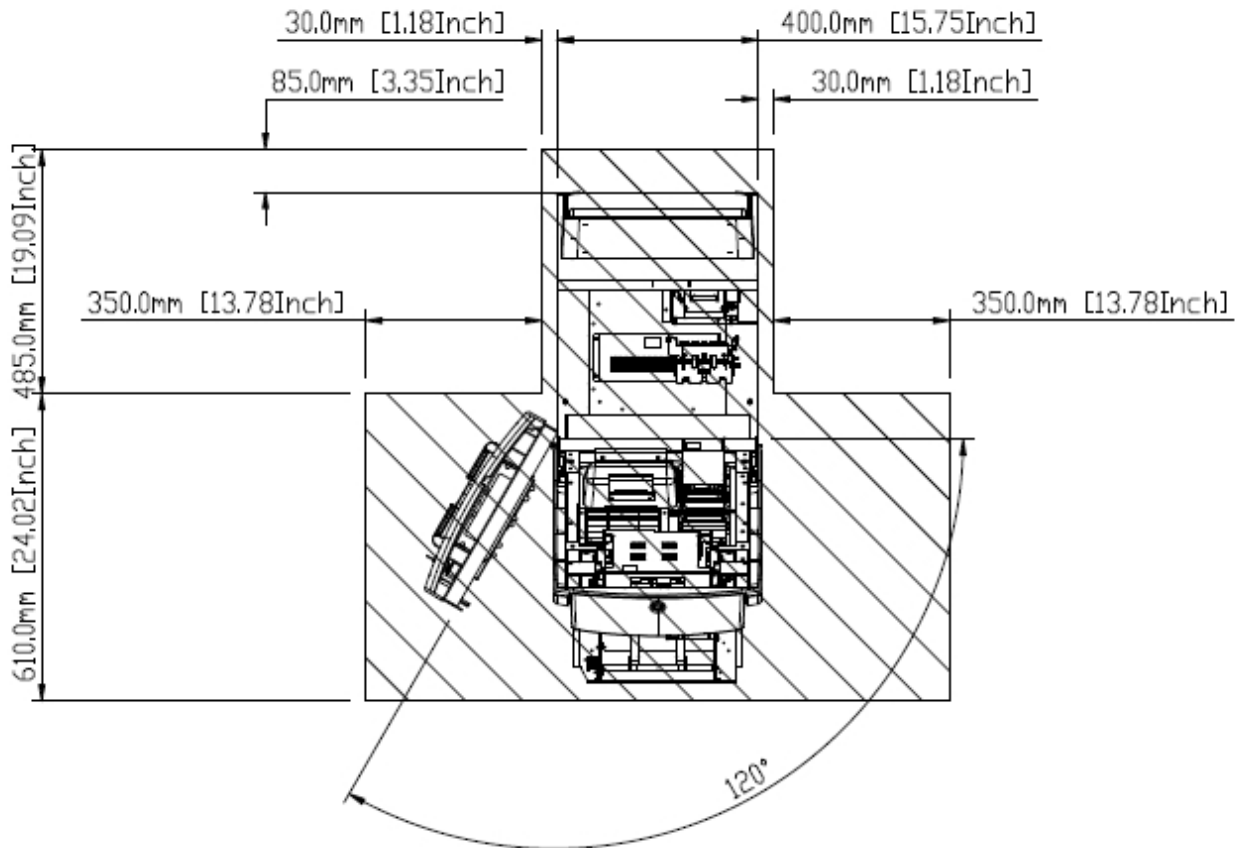

Fig.6.2 Installation space #1 (Plane view)

NOTE: All the unit in the dimension is mm and the unit in the parenthesis is inch.

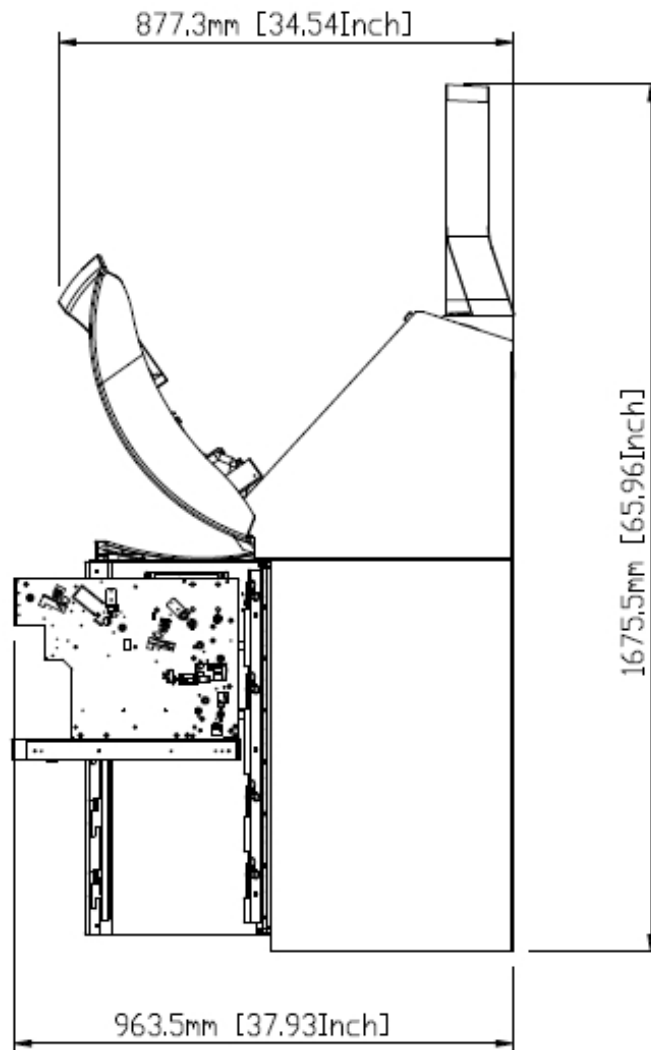

Fig. 6.3 Installation space #2 (Side view)

NOTE: All the unit in the dimension is mm and the unit in the parenthesis is inch.

Hyoung recommends it is more convenient for your service personnel to have enough maintenance space as described above to service this ATM.

Chapter 7. Appendix

7. Appendix

7.1 Error Code Table

1) Receipt Printer

Error Code	Description	Trouble shooting
1106910	LOST SLIP", DEV_SPR	
2001000	Receipt paper jam	Remove any jammed paper from the printer.
2001200	Receipt printer feed plate open	Close the feed plate.
2001300	Out of receipt (Receipt paper empty)	Replenish the receipt paper.
2001400	Receipt printer head overheated before printing	Check the printer head and change if necessary.
2010100	Receipt printer lever opened	Close the lever of print head completely
2010200	Receipt printer head overheated	Wait the time until the temperature of head adequately slow down and try to initialize
2010300	Receipt paper jam	Remove jammed paper between printer head and rollers
2010400	Receipt paper empty	1. Replenish receipt paper 2. Check the status of sensor and its connector
2010500	Receipt paper setting error	1. Check the status of setting paper 2. Check the status of sensor and its connector
2010600	Command is received while doing self-test	After terminating self-test and initialize receipt printer
2010700	No receipt paper	1. Replenish receipt paper in paper charger 2. Check the status of Near End sensor and its connector
2010800	Receipt paper cutting error	1. Check the Cutter module 2. Check if printer head lever is properly close
2010900	No sensing black mark (dark sensor)	1. Check the status of Black mark sensor 2. Check if Dip switch # 6 is correctly set (Dip switch # 6 is set by On in case of not using Black mark)
2010A00	The size of image print data is abnormal	Check the AP version and initialize

Error Code	Description	Trouble shooting
2080100	Receipt printer lever opened	Close the lever of print head completely
2080200	Receipt printer head overheated	Wait the time until the temperature of head adequately slow down and try to initialize
2080300	Receipt paper jam	Remove jammed paper between printer head and rollers
2080400	Receipt paper empty	1. Replenish receipt paper 2. Check the status of sensor and its connector
2080500	Receipt paper setting error	1. Check the status of setting paper 2. Check the status of sensor and its connector
2080600	Command is received while doing self-test	After terminating self-test and initialize receipt printer
2080700	No receipt paper	1. Replenish receipt paper in paper charger 2. Check the status of Near End sensor and its connector
2080800	Receipt paper cutting error	1. Check the Cutter module 2. Check if printer head lever is properly close
2080900	No sensing black mark (dark sensor)	1. Check the status of Black mark sensor 2. Check if Dip switch # 6 is correctly set (Dip switch # 6 is set by On in case of not using Black mark)
2080A00	The size of image print data is abnormal	Check the AP version and initialize
2080B00	Margin setting error	1. Check whether the default registry setting is changed 2. Reset the PTR SP
2080C00	Paper jammed at the exit of the slot	1. Remove the jammed paper
2080D00	Paper jammed in the path	1. Remove the jammed paper
2080F00	The firmware crashed	1. Check whether the dip switch #1 is set to "ON" position 2. Update the firmware
2DN0000	Failed to connect communication between Receipt printer and SP	1. Check if communication cable or com port is not connected
9720000	Receipt printer communication error during SP opening	Check if communication cable or COM port is not connected
9722010	Receipt Printer communication failure during COM port open	1. Do RESET at Operator Function 2. Reboot ATM
9722DN0	Receipt Printer communication failure during sending command to Receipt Printer	1. Do RESET at Operator Function 2. Reboot ATM

Error Code	Description	Trouble shooting
97912XX	DEV_SPR Time Over Error	1. Reboot ATM 2. Call your attendant
97922XX	DEV_SPR FATALERROR (WARNING)	1. Reboot ATM 2. Call your attendant
A010100	Open lever detected before executing command	Close the feed lever.
A010200	Printer thermal head overheated while executing command	Check the thermal printer head and change if necessary.
A010300	Paper jam detected before executing command	Remove any jammed paper from the printer.
A010400	Paper setting error detected before executing command	Remove and re-install the receipt paper.
A010500	Paper check error detected before executing command	Remove and re-install the receipt paper.
A010800	Paper cutter software check error detected before executing command	Check for and remove any jammed paper.
A080100	Open lever detected while executing command	Remove any jammed paper.
A080200	Receipt printer head overheated while printing	Check the thermal printer head and change if necessary.
A080300	Paper jam detected while executing command	Remove and re-install the receipt paper.
A080400	Paper setting error detected before executing command	Remove and re-install the receipt paper.
A080500	Paper check error in doing command	Remove any jammed paper.
A080800	Paper cutter software check error detected while executing command	Check for and remove any jammed paper.
ADN0100	No response detected for 30 seconds after sending command	Check cable and connection between the CE and printer.
ADN0F00	No response detected for 30 seconds after sending command	Check cable and connection between the CE and printer.
ADN1100	No response detected after 3 retries	Check cable and connection between the CE and printer.
ADN1200	No response detected between ENQ-ACK after 5 retries of ENQ	Check the cable and connection between the CE and printer.
ADN1300	No response detected after 5 retries because of timeout between STX-BCC interval	Check cable and connection between the CE and printer.

2) Card Reader

Error Code	Description	Trouble shooting
8217091	Card in card reader	Remove card
1101910	LOST CARD", DEV_MCU	
9723010	Failed to open device	Check the serial port or cable
9723011	Communication error	Check the serial port or cable
9723016	Time out to receive data	Check the serial port or cable
9723019	Polling down	Check the serial port or cable
9730100	IC CARD DENIAL	
9730200	IC CARD ONLINE DATA ERROR	
9730300	IC CARD ERROR	
97913XX	DEV_MCU Time over Error Code	1. Reboot ATM 2. Call your attendant
97923XX	DEV_MCU FATALERROR (WARNING)	1. Reboot ATM 2. Call your attendant
9799301	MCU RETRACT OVER	Clear the count of retracted card at OP mode
90001	Card Read Error	1. Check Magnetic Card 2. Check Card Read module and cable connection
90002	Invalid IC card communication	1. Power Off/On 2. Check DIP MCR 3. Check cable connection
90003	DIP MCR latch failure	1. Power Off/On 2. Check DIP MCR (Clamp Lever) 3. Check cable connection
90004	DIP MCR unlatch failure	1. Power Off/On 2. Check DIP MCR (Clamp Lever) 3. Check cable connection
90005	DIP MCR power on failure	1. Power Off/On 2. Check DIP MCR 3. Check cable connection
90006	DIP MCR power off failure	1. Power Off/On 2. Check DIP MCR 3. Check cable connection

D0006	CARD NOT SUPPORTED	Check your card
D0014	Invalid Card Number	Check your account
D0054	Expire Card	Check your card
D0057	Transaction not Permitted – Card	Check your card
IDN0X	DIP MCR connection failure	<ol style="list-style-type: none"> 1. Power Off/On 2. Check DIP MCR 3. Check cable connection

3) Cash Dispenser

Error Code	Description	Trouble shooting
1102910	LOST WITHDRAW CASH", DEV_CSH	
1102920	LOST DEPOSIT CASH", DEV_CSH	
1103910	LOST CARD & SLIP", DEV_MCU DEV_SPR	
2000100	No cassette	Insert or re-insert the cassette(s). Check cassette sensor.
2000200	Note shortage	Replenish the cassette.
2000300	Reject bin full	Remove notes from the reject bin and try the Cassette Total function again.
2000500	Cash Dispenser Unit data setting error	Check Cash Dispenser Unit information. (Currency, Denomination, etc)
2001600	Note detected in stacker (shutter or presenter type)	Clear any notes from the stacker.
2021500	Sensor detects note in delivery path before CDU dispenses	Remove note from the CDU delivery path.
2131500	CS4 sensor detects note in delivery path before CDU dispenses. Sensor is located along the delivery path right before the reject bin.	Remove note from the CDU delivery path.
21A1500	CS1A sensor detects note in delivery path before CDU dispenses. Sensor is located along the delivery path right after where the note exits the 1st cassette.	Remove note from the CDU delivery path.
21B1500	CSB sensor detects note in delivery path before CDU dispenses. Sensor is located along the delivery path right after where the note exits the 1st cassette.	Remove note from the CDU delivery path.
24A1500	CS3A sensor detects note in delivery path before CDU dispenses. Sensor is located along the delivery path right after where the note exits the 3rd cassette.	Remove note from the CDU delivery path.
24B1500	CS3B sensor detects note in delivery path before CDU dispenses. Sensor is located along the delivery path right after where the note exits the 3rd cassette.	Remove note from the CDU delivery path.
40000	Receive undefined command.	

Error Code	Description	Trouble shooting
4000000	Cash Dispenser(CDU) received the undefined command from AP software	1. Get the trace file and log files in D:\trace 2. Call your attendant
4001100	Detecting CS2 / LS3 Dark (Front Access Type : Reject box is opened.)	1. Remove notes on CS2 / LS3 sensor 2. Clean CS2 / LS3
40014	- Detect CS4A after initialization. - Detect CS4A before dispensing.	
4001400	CS4A / LS9 sensor detects note in delivery path before/after CDU dispenses	1. Remove note from the CDU delivery path. 2. Clean CS4A / LS9
4001500	CS2 or CS4A sensor detects note in delivery path before/after CDU dispenses	1. Remove note from the CDU delivery path. 2. Clean CS2 and CS4A
40018	- Detect CS4B after initialization. - Detect CS4B before dispensing.	
4001800	CS4B sensor detects note in delivery path before/after CDU dispenses	1. Remove note from the CDU delivery path. 2. Clean CS4B
4001900	CS2 or CS4B sensor detects note in delivery path before/after CDU dispenses	1. Remove note from the CDU delivery path. 2. Clean CS2 and CS4B
4001C	- Detect CS4A & CS4B after initialization. - Detect CS4A & CS4B before dispensing.	
4001C00	CS4A or CS4B sensor detects note in delivery path before/after CDU dispenses	1. Remove note from the CDU delivery path. 2. Clean CS4A and CS4B
4001D00	CS2, CS4A or CS4B sensor detects note in delivery path before/after CDU dispenses	1. Remove note from the CDU delivery path. 2. Clean CS2, CS4A and CS4B
40021	Detect CS1A after initialization / Detect CS1A before dispensing.	
4002100	CS1A / LS1 sensor detects note in delivery path before/after CDU dispenses	1. Remove note from the CDU delivery path. 2. Clean CS1A / LS1
40022	Detect CS1B after initialization / Detect CS1B before dispensing.	
4002200	CS1B sensor detects note in delivery path before/after CDU dispenses	1. Remove note from the CDU delivery path. 2. Clean CS1B
40023	Detect CS1A & CS1B after initialization / Detect CS1A & CS1B before dispensing.	

Error Code	Description	Trouble shooting
4002300	CS1A or CS1B sensor detects note in delivery path before/after CDU dispenses	1. Remove note from the CDU delivery path. 2. Clean CS1A and CS1B
40028	Detect CS13 after initialization / Detect CS13 before dispensing.	
4002800	CS13 sensor detects note in delivery path before/after CDU dispenses	1. Remove note from the CDU delivery path. 2. Clean CS13
40029	Detect CS13 & CS1A after initialization / Detect CS13 & CS1A before dispensing.	
4002900	CS1A or CS13 sensor detects note in delivery path before/after CDU dispenses	1. Remove note from the CDU delivery path. 2. Clean CS1A and CS13
4002A	Detect CS13 & CS1B after initialization / Detect CS13 & CS1B before dispensing.	
4002A00	CS1B or CS13 sensor detects note in delivery path before/after CDU dispenses	1. Remove note from the CDU delivery path. 2. Clean CS1B and CS13
4002B	Detect CS13 & CS1A & CS1B after initialization / Detect CS13 & CS1A & CS1B before dispensing.	
4002B00	CS1A, CS1B or CS13 sensor detects note in delivery path before/after CDU dispenses	1. Remove note from the CDU delivery path. 2. Clean CS1A, CS1B and CS13
40030	(INITIAL / DISPENSE) Motor Constant Speed Error	
4003000	Failed in checking the main motor echo	1. Initialize 2. Check Main Motor Encoder Slit 3. Initialize after Power On/Off 4. Check Encoder Sensor CS8 BRKT 5. Check CS8 Sensor Cable 6. Change Main Motor Encoder Slit Sensor CS8
40031	(INITIAL / DISPENSE) SOLENOID ECHO Error	
4003100	Failed in checking the reject gate solenoid echo	
4003200	Failed in checking the present gate solenoid echo	

Error Code	Description	Trouble shooting
4003300	Check sum error (No information is set)	<ol style="list-style-type: none"> 1. Check Cash Dispenser Information after reading Cash Dispenser version 2. Initialize 3. Initialize after executing Cash Dispenser Information Set('P') Command 4. Change Cash Dispenser B/D
4003400	Error of two sheets detecting sensor(CS5_1) for initializing	<ol style="list-style-type: none"> 1. Check CS5_1 Sensor Cable 2. Check second Dip Switch in Cash Dispenser B/D 3. Change CS5_1 Sensor
40036	Detect CS13 before initialization.	
4003600	Error of CS 2, CS13 / LS2 sensor during initialization	<ol style="list-style-type: none"> 1.Remove a jammed note in CS13 / LS2 sensor. 2.Replace CS13 / LS2 sensor.
4003700	Error of 2 sheets detecting sensor (CS5_1 / CS5_2) for dispensing	<ol style="list-style-type: none"> 1. Check Cash Dispenser Board Segment 2. Initialize 3. Read data of 'Read Double Sensor' Command
4003800	Error in checking SRAM	
40039	(INITIAL / DISPENSE) Solenoid Operation Error before motor activation	
4003900	Gate operation sensor (CS3 / LS8) error before initial recovery	<ol style="list-style-type: none"> 1. Initialize after removing notes or dust over Gate 2. Check CS3 / LS8 Sensor BKRT 3. Check CS3 / LS8 Sensor Cable 4. Exchange Sensor after abnormal operating CS3 / LS8 Gate detecting Sensor 5. Replace Reject Solenoid 1
4003A00	When more than 5 sheets of cash dispensing is required during a test	<ol style="list-style-type: none"> 1. Check command that Cash Dispenser is received 2. Check Cash Dispenser EP ROM Version or specification
4003B00	When CS15A or CS 15B sensor is detected as dark after initial recovery	<ol style="list-style-type: none"> 1. Remove notes or dust on CS15A Sensor 2. Check CS15A Sensor Cable 3. Exchange Sensor after abnormal operating CS15A Sensor
40040	(DISPENSE) Reboot 5 or more times due to cassette separation	
4004000	Cassette is removed during dispensing	<ol style="list-style-type: none"> 1. Check the cassette catcher 2. Set the cassette properly
40041	(DISPENSE) Reboot 12 or more times	

Error Code	Description	Trouble shooting
4004100	Error if re-driving is over 5 times during separated rejection	<ol style="list-style-type: none"> 1. Check notes in Reject Box 2. Rearrange notes in Cassette 3. Remove dust in CS15AB, CS31AB, CS41AB CS1AB Sensor 4. Check dust existing in CS5 Sensor Guide 5. Check dust existing in Main Motor Encoder Slit 6. Check index value of notes each cassette
40042	(DISPENSE) The dispensed number of notes is less than requested.	
4004200	In case the number of notes detected outlet sensor(CS13 / LS2) is less than the number of required notes	<ol style="list-style-type: none"> 1. Check notes dispensed and rejected 2. Remove notes jammed in CDU 3. Remove dust in CS13 / LS2 Sensor 4. Exchange sensor after abnormal operating CS13 / LS2 Sensor
40043	(DISPENSE) Reject more than 40 sheets.	
4004300	Error if total reject is more than 20 sheets	<ol style="list-style-type: none"> 1. Check notes in Reject Box 2. Rearrange notes in Cassette 3. Remove dust in CS1AB, CS15AB, CS31AB, CS41AB Sensor 4. Check dust in existence CS5 Sensor Guide 5. Check notes index value
4004400	Error if continuous 5 times are rejected	<ol style="list-style-type: none"> 1. Check notes in Reject Box 2. Rearrange notes in Cassette 3. Check dust in Main Motor Encoder Slit 4. Remove dust in CS15AB, CS31AB, CS1AB Sensor 5. Exchange CS8 Encoder Slit Sensor
40045	(DISPENSE) The dispensed number of notes is more than requested during/after operation	
4004500	In case the number of notes detected outlet sensor(CS13 / LS2) is more than required notes	<ol style="list-style-type: none"> 1. Check notes dispensed and rejected 2. Remove dust in CS13 / LS2 Sensor 3. Exchange sensor after abnormal operating CS13 / LS2 Sensor
4004600	Program error(Separated rejection)	<ol style="list-style-type: none"> 1. Initialize after Reset Power 2. Upgrade Cash Dispenser Firmware or re-download 3. Exchange Cash Dispenser B/D
40047	(DISPENSE) Reboot 5 or more times due to miss pick up	

Error Code	Description	Trouble shooting
4004700	1 cassette mis-feed error (Separated rejection)	<ol style="list-style-type: none"> 1. Check notes in 1 Cassette 2. Check Sensor(CS6) Poll 3. Check jam in 1 cassette and reload 4. Remove dust in CS1A, CS1B Sensor 5. Exchange 1 cassette box when there are many error
4004800	Error if the number of dispensed notes is not matched to the requested	<ol style="list-style-type: none"> 1. Check CS13 sensor (note jam and dust) 2. Replace CS13 sensor
40049	(DISPENSE) Received the number of requirement by "0".	
4004900	Error to dispense 0 sheets to be required (Separated rejection)	<ol style="list-style-type: none"> 1. Check received command 2. Check communication cable 3. Check Cash Dispenser Firmware Version
4004A	(DISPENSE) Jam during dispensing.	
4004A00	Error of note jam (Separated rejection)	<ol style="list-style-type: none"> 1. Remove jammed notes on Cash Dispenser return path 2. Remove dust in CS1~CS4 sensor 3. Install after rearranging notes in cassette
4004B00	Continuous 3 times error if note is long (once tried, twice retried)=>Separated rejection	<ol style="list-style-type: none"> 1. Check state of notes in reject box 2. Rearrange notes in cassette 3. Check Index of notes 4. Check foreign objects in the main motor encoder slit 5. Replace the CS8 encoder slit sensor
4004C00	In case the number of notes detected outlet sensor(CS13/ LS2) is more than that of notes detected on CS1A,B sensor	<ol style="list-style-type: none"> 1. Check CS1 sensor 2. Reconnect CS1 sensor
4004D	(DISPENSE) Cassette separation before operation.	
4004D00	Error of being removed 1st cassette before separate rejection	<ol style="list-style-type: none"> 1. Set cassette #1 correctly 2. Check the catcher inside cassette #1 guide
4004E00	Error of being removed 2nd cassette before separate rejection	<ol style="list-style-type: none"> 1. Set cassette #2 correctly 2. Check the catcher inside cassette #2 guide
40051	(DISPENSE) Received the required number of notes 150 or more.	
4005100	Received a request for over 150 notes dispensing on the Cash Dispenser from the upper unit.	<ol style="list-style-type: none"> 1. Check the Cash Dispenser received command 2. Check the abnormal communication cable. 3. Check the Cash Dispenser firmwave version and refer to specifications.
4005200	The remaining notes at the sensor in front of the CST after dispense operation (CS1A, CS1B)	<ol style="list-style-type: none"> 1. Remove the remaining notes at a sensor in front of the CST 2. Realign notes in the cassette 3. Check abnormal clutch. 4. Check abrasion of the cassette box pick unit.

Error Code	Description	Trouble shooting
4005300	Error for the double note detection during separation.	
4005400	Cash Dispenser EP Program Error during dispense operation (failed table search)	<ol style="list-style-type: none"> 1. Initialize after resetting the power 2. Upgrade the Cash Dispenser firmware or download software again 3. Replace the Cash Dispenser B/D
40055	(DISPENSE) Detect CS13 during constant speed of motor / CS13 Jam during dispensing.	
4005500	Timeout due to note's length error passed through the CS13 / LS2 during dispense operation	<ol style="list-style-type: none"> 1. Remove a jammed note between the tray and Cash Dispenser 2. Remove a jammed note at the position of the CS13 / LS2 sensor 3. Remove a dust on the CS13 / LS2 sensor
40056	(DISPENSE) Solenoid Error during dispensing.	
4005600	Abnormal operation of the gate solenoid during dispense operation.	<ol style="list-style-type: none"> 1. Remove a jammed note on the gate 2. Remove notes in the reject box and remount the reject box 3. Check if the CS3 / LS8 sensor bracket is bended. 4. Check if the CS3 / LS8 sensor cable is Disconnected (CN10 #9~10) 5. Exchange a sensor after abnormal operating CS3 / LS8 Gate detecting sensor. 6. Replace the reject solenoid 1
4005700	Cash dispenser configuration error	<ol style="list-style-type: none"> 1. Replace cash dispenser PCB 2. Reconfigure cash dispenser setup data
4005800	Retract box position error during command reserved operation	<ol style="list-style-type: none"> 1. Mount the retract box or open the box cover 2. Check if CS62 sensor poll is abnormal 3. Check if the CS62 sensor cable is disconnected (Cash Dispenser Board CN10 #5~2).
4005900	Initial jam time error	<ol style="list-style-type: none"> 1. Remove jammed notes 2. Clean the sensors (CS1~CS15) in cash dispenser
4005B00	2 Cassette Miss Feed Error (Fail to reject bill separately.)	
4005D00	Continuously detected 2 notes for three times or more during dispense operation	<ol style="list-style-type: none"> 1. Check notes' status in the reject box 2. Realign notes in the cassette 3. Check foreign objects at the position of the CS5 Sensor Guide 4. Check if the CS5 cable is disconnected (CS5_1:Cash Dispenser B/D CN10 #11~12, 25~28/ CS5_2:CN12)

Error Code	Description	Trouble shooting
4006000	Something is detected in C31AB sensor before dispensing bills from 3rd cassette.	
4006100	Something is detected in C31AB sensor before dispensing bills.	
4006200	Bills are remained in CS1AB sensor after dispensing bills.	
4006300	Bills are remained in CS31AB sensor after dispensing bills	
4006A00	CS15AB ~ CS13 Time out(Jam) during dispensing bills from second cassette.	
4006B00	Something is detected on CS31A, CS31B sensor during initialization	
4007000	Something is detected on CS41AB sensor before dispensing bills from fourth cassette.	
4007200	Something is detected on CS41AB sensor during dispensing bills.	
4007300	Bills is remained in CS41AB sensor after dispensing bills.	
4007A00	CS31AB ~ CS13 Time out (Jam) during dispensing bills from fourth cassette.	
4007B00	Something is detected on CS41A, CS41B sensor in initialization	
4007C00	Missfeed error in 4th cassette	
4007D00	Trying to dispense bills from 4th cassette but the 4th cassette doesn't installed.	
4008000	Something is detected on CS15AB sensor before dispensing operation	
4008100	Something is detected in C15AB sensor during dispensing operation	
4008200	Bill is remained in CS15AB sensor after dispensing operation	

Error Code	Description	Trouble shooting
40088	(DISPENSE) Dispense the notes on the state of unsupported denomination setting.	
4008F00	CS13 sensor detects a bill with hole during dispensing	
40090	Decryption Error / Key Error	
40091	Receive CMD except certification on the status of non-certification.	
40092	Encryption Chip Communication Error	
40093	0xC1 Command Execution Error (Certification Fail)	
40094	0xC2 Command Execution Error (Certification Fail)	
4009A00	CS31AB~CS13 Time out(Jam) during dispensing from 3rd cassette.	
4009D00	Trying to dispense bills from 3rd cassette but the 3rd cassette doesn't installed.	
4009F00	3 cassette miss feed error	
400AC00	Something is detected on CS2 sensor after dispense operation	
400BC00	Communication error - Command Length doesn't match.	
400BD	(Set CDU Info) CDU Type Setting Error	
400BE	(DISPENSE) Jam on the transport during operation (CS4 A/B Dark)	
400BE00	Bill pickup sensor(CS1, CS15) recognized has a hole and CS4 sensor detects it or CS4 sensor detects the gap too close	
400BF	(Initialize, Dispense) No Encoder Signal 150ms or more during operation.	

Error Code	Description	Trouble shooting
400C100	Cassette Jam during dispense operation (1 CST Encoder Error).	1.Remove a jammed note in 1 Cassette. 2.Replace 1 cassette box when multiple errors occur.
400C200	Cassette Jam during dispense operation (2 CST Encoder Error).	1.Remove a jammed note in 2 Cassette. 2.Replace 2 cassette box when multiple errors occur.
400C300	Cassette Jam during dispense operation (3 CST Encoder Error).	1.Remove a jammed note in 3 Cassette. 2.Replace 3 cassette box when multiple errors occur.
400C400	Cassette Jam during dispense operation (4 CST Encoder Error).	1.Remove a jammed note in 4 Cassette. 2.Replace 4 cassette box when multiple errors occur.
400C6	Detect CS13 during initialization.	
400C600	Error of CS 2, CS13 sensor during initialization	1.Remove a jammed note in CS13 sensor. 2.Replace CS13 sensor.
400C700	Something is detected on CS12 sensor during dispensing bills or initialization.	
400C800	Something is detected on CS14 sensor during dispensing bills or initialization.	
400C900	Something is detected on CS14 sensor after dispense operation	
400CC	(DISPENSE) Detect CS1A, CS1B just before reset.	
400CC00	Bill is remained on the sensor in front of cassette during resetting.	
400D000	Bills are passed on CS13~CS12 sensor - Timeout[Jam].	

Error Code	Description	Trouble shooting
400D100	Bills are passed on CS12~CS14 sensor - Timeout[Jam].	
400D7	DIP Switch Setting Error	
400FF00	Bill jam	1. Remove the jammed notes 2. Initialize
4DN0000	Cash Dispenser communication failure during sending command to cash dispenser	1. Do RESET at Operator Function 2. Reboot ATM
4DN0100	Cash Dispenser communication failure during receiving command to cash dispenser	1. Do RESET at Operator Function 2. Reboot ATM
4DN8100	Communication error of Shutter	
8216091	Cash jammed on Cash Dispenser	1. Remove jammed notes on Cash Dispenser return path 2. Remove dust in CS1~CS4 sensor
9712000	Failed to create file	1. Reboot ATM 2. Reinstall software 3. Replace hard disk drive
9712100	Failed to read file	1. Reboot ATM 2. Reinstall software 3. Replace hard disk drive
9712200	Failed to write file	1. Reboot ATM 2. Reinstall software 3. Replace hard disk drive
9712300	Failed to close file	1. Reboot ATM 2. Reinstall software 3. Replace hard disk drive
9712400	Failed to delete file	1. Reboot ATM 2. Reinstall software 3. Replace hard disk drive
9712500	Failed to copy file	1. Reboot ATM 2. Reinstall software 3. Replace hard disk drive
9712600	Failed to create directory	1. Reboot ATM 2. Reinstall software 3. Replace hard disk drive
9719000	Failed to execute an extra command in the status of Cash Unit Exchange	1. Reboot ATM 2. Reinstall software 3. Replace hard disk drive
9719100	In case of not being the status of Cash Unit Exchange out of End Exchange	1. Reboot ATM 2. Reinstall software 3. Replace hard disk drive
9719200	In case of carrying out Cash In Start command at two times	1. Reboot ATM 2. Reinstall software 3. Replace hard disk drive

Error Code	Description	Trouble shooting
9719300	In case of not being the status of Cash In out of End Cash In	1. Reboot ATM 2. Reinstall software 3. Replace hard disk drive
9719400	Invalid Cash Unit ID	Reconfigure cash dispenser setup data
9719500	Invalid Cash Unit number	Reconfigure cash dispenser setup data
9719600	The abnormal of the number of Cash Unit	Reconfigure cash dispenser setup data
9719700	No. of dispensed notes that software counts is not matched to it cash dispenser responded	1. Initialize after resetting the power 2. Upgrade the Cash Dispenser firmware or download software again 3. Replace the Cash Dispenser B/D
971A000	Invalid denomination	Reconfigure denomination at supervisor mode
971A100	Invalid currency	Reconfigure currency at supervisor mode
971A200	CASSETTE OFF POSITION". Not dispensable	1. Reconfigure denomination 2. Reconfigure currency
971A300	In case the number of bills dispensed exceeds the maximum dispensing bill	1. Check cash dispenser driver (CDM SP) version 2. Reconfigure the maximum dispensable count
971A400	In case the number of coins dispensed exceeds the maximum dispensing coin	1. Check coin dispenser driver version 2. Reconfigure the maximum dispensable count
971A500	Invalid mix number	1. Reconfigure cash dispenser at supervisor mode
971A600	In case automatic Retry of SP fails 3 times	
971A700	There is no setting information about automatic Retry standard	
971B000	In case of being executed Reject or Retract command without being the bills in stacker.	1. Check a dust in stacker 2. Reconfigure the maximum dispensable count
971C000	Not supported command	Reinstall software
971D100	Partial dispense	1. Check the replenished amount and replenish 2. Check the notes in cassette #1
971D200	Partial dispense from cassette #2	1. Check the replenished amount and replenish 2. Check the notes in cassette #2
971D300	Partial dispense from cassette #3	1. Check the replenished amount and replenish 2. Check the notes in cassette #3

Error Code	Description	Trouble shooting
971DX00	In case partial bills dispensed by dispensing demand when Partial Dispense option is on. "X" means cassette number.	
9740000	Cash Dispenser communication failure during COM port open	1. Do RESET at Operator Function 2. Reboot ATM
9740101	In case incorrect cassette type is set.	
9740102	In case nonexistent Note Index is set.	
9741100	When sensing CS2 Dark (Error code, 400FF00 is subdivided by location of sensor.)	
9741400	When sensing CS4A Dark (Error code, 400FF00 is subdivided by location of sensor.)	
9741800	When sensing CS4B Dark (Error code, 400FF00 is subdivided by location of sensor.)	
9742100	When sensing CS21A,B Dark (Error code, 400FF00 is subdivided by location of sensor.)	
9742800	When sensing CS13 Dark (Error code, 400FF00 is subdivided by location of sensor.)	
9743B00	When sensing CS15A,B Dark (Error code, 400FF00 is subdivided by location of sensor.)	
9744700	Cash picking-up fail while cash in cassette #1 is enough	1. Check bill jam or no note in cassette #1 2. Check cash dispenser
9745B00	Cash picking-up fail while cash in cassette #2 is enough	1. Check bill jam or no note in cassette #2 2. Check cash dispenser
9746B00	When sensing CS31A,B Dark (Error code, 400FF00 is subdivided by location of sensor.)	
9747B00	When sensing CS41A, B Dark (Error code, 400FF00 is subdivided by location of sensor.)	
9747C00	Cash picking-up fail while cash in cassette #4 is enough	1. Check bill jam or no note in cassette #2 2. Check cash dispenser
974FF00	When sensing bills in the Stacker (Error code, 400FF00 is subdivided by location of sensor.)	

Error Code	Description	Trouble shooting
9749F00	Cash picking-up fail while cash in cassette #3 is enough	1. Check bill jam or no note in cassette #2 2. Check cash dispenser
97914XX	DEV_Cash Dispenser Time over Error Code	1. Reboot ATM 2. Call your attendant
97924XX	DEV_Cash Dispenser FATAL ERROR (WARNING)	1. Reboot ATM 2. Call your attendant
9799499	DISPENSER COUNT ERROR	Check the sensor on cash dispenser
C004F00	The Number of dispensed notes does not match	1. Check the number of dispensed notes. 2. Perform a test on the Cash Dispenser Unit.

4) Modem

Error Code	Description	Trouble shooting
D030000	Modem is not responding	Check the modem controller.
D030100	The target call address has call blocking enabled.	1. Check modem cable 2. Contact to technician support team
D030200	The specified terminal identifier is invalid.	1. Check modem cable 2. Contact to technician support team
D030300	All call appearances on the specified address are currently in use.	1. Check modem cable 2. Contact to technician support team
D030400	The disable address parameter contains dialing control characters that are not processed by the service provider.	1. Check modem cable 2. Contact to technician support team
D030500	The specified country/region code is invalid.	1. Check modem cable 2. Contact to host and phone company
D030600	The operation failed for an unspecified or unknown reason.	Contact to technician support team
D030700	Insufficient resources to complete the operation	Contact to technician support team

5) Miscellaneous

Error Code	Description	Trouble shooting
1030100	DEV_PIN (Key data error from host)	Contact to host
2000400	Vault door open	Close the vault door. Check door switch.
9701010	Failed to connect communication between SP of PIN and EP of one	Check if communication cable or COM port is not connected
9701012	Failed to deliver to data of EPP's SP	Check if communication cable or COM port is not connected
9701016	Received data time out of EPP	Check if communication cable or COM port is not connected
9701017	Delivered data time out of EPP	Check if communication cable or COM port is not connected
9701031	Failed to read Register of EPP	Reboot ATM
9701040	Failed to produce Thread of EPP	Reboot ATM
9701060	Failed to create buffer	Reboot ATM
9701111	BCC error of EPP	Check BCC logic of EPP
9701151	EPP is down when it receives an 'Get Status' command	1. Reboot ATM 2. Replace pinpad
9701152	EPP is down when it receives an 'Clear Func Key' command	1. Reboot ATM 2. Replace pinpad
9722020	File Open Error	1. Reboot ATM 2. Call your attendant
9722060	Memory Allocate Error (PrintForm Allocate IndexBuffer Fail)	1. Reboot ATM 2. Call your attendant
9722068	Invalid Media Name	1. Reboot ATM 2. Call your attendant
97221A2	Invalid Unit	1. Reboot ATM 2. Call your attendant
97221C1	Form is not Found	1. Reboot ATM 2. Call your attendant
97221C4	Form Name is NULL	1. Reboot ATM 2. Call your attendant
97221C5	Invalid Form	1. Reboot ATM 2. Call your attendant

Error Code	Description	Trouble shooting
97221C6	PrintForm() offset is Invalid	1. Reboot ATM 2. Call your attendant
97221C7	Invalid Form (Too many Fields)	1. Reboot ATM 2. Call your attendant
97221D1	Media is not Found	1. Reboot ATM 2. Call your attendant
97221D3	Media Overflow when form size is larger than media size	1. Reboot ATM 2. Call your attendant
97221D4	Media Name is NULL	1. Reboot ATM 2. Call your attendant
97221D5	Invalid Media (Attribute for Media definition is not proper)	1. Reboot ATM 2. Call your attendant
97221D6	Invalid Media (Area size is larger than media size)	1. Reboot ATM 2. Call your attendant
97221D7	Invalid Media (Size of Media Name is exceeded to 2048 bytes totally)	1. Reboot ATM 2. Call your attendant
97221E1	Field is not Found	1. Reboot ATM 2. Call your attendant
97221E2	Field Error (This Field must have initial value)	1. Reboot ATM 2. Call your attendant
97221E3	Non-Indexed value for Indexed Field	1. Reboot ATM 2. Call your attendant
97221E4	Invalid Field	1. Reboot ATM 2. Call your attendant
97221E5	Invalid Field (This Field's width is 0)	1. Reboot ATM 2. Call your attendant
9740020	Failed to create file	1. Reboot ATM 2. Call your attendant
9740025	Failed to copy file	1. Reboot ATM 2. Call your attendant
9745500	System power off while dispensing	

Error Code	Description	Trouble shooting
97915XX	DEV_BRM Time over Error Code	1. Reboot ATM 2. Call your attendant
97916XX	DEV_PBM Time over Error Code	1. Reboot ATM 2. Call your attendant
97918XX	DEV_PIN Time over Error Code	1. Reboot ATM 2. Call your attendant
9791AXX	DEV_FNG Time over Error Code	1. Reboot ATM 2. Call your attendant
9791BXX	DEV_VFD Time over Error Code	1. Reboot ATM 2. Call your attendant
97925XX	DEV_BRM FATALERROR (WARNING)	1. Reboot ATM 2. Call your attendant
97926XX	DEV_PBM FATALERROR (WARNING)	1. Reboot ATM 2. Call your attendant
97928XX	DEV_PIN FATALERROR (WARNING)	1. Reboot ATM 2. Call your attendant
9792AXX	DEV_FNG FATALERROR (WARNING)	1. Reboot ATM 2. Call your attendant
9792BXX	DEV_VFD FATALERROR (WARNING)	1. Reboot ATM 2. Call your attendant
9799901	DOOR CHECK	1. Reboot ATM 2. Call your attendant
9799902	LIGHT ERROR	1. Reboot ATM 2. Call your attendant
9799903	SPL ERROR	1. Reboot ATM 2. Call your attendant
9799904	PIN ERROR	1. Reboot ATM 2. Call your attendant
9799905	SENSOR CHECK	1. Reboot ATM 2. Call your attendant
9799907	UPS ERROR	1. Reboot ATM 2. Call your attendant

Error Code	Description	Trouble shooting
9799908	SCREEN ERROR	1. Reboot ATM 2. Call your attendant
991@@@91	ON TRANSACTION POWER OFF	1. Check power supply 2. Check backup battery
D000100	Error while modem initializing	Check the modem connection and the modem test.
D000200	Reversal transaction failure	Check for any CDU error codes and the number of notes dispensed to customer.
DA(0)00300	PIN ERROR	Transaction was denied by host
DA(0)00400	INVALID PIN	Reboot ATM
DA(0)00500	BANK UNAVAILABLE	Transaction was denied by host
DA(0)00600	CARD NOT SUPPORTED	Transaction was denied by host
DA(0)00700	INSUFFICIENT FUNDS	Transaction was denied by host
DA(0)00800	INELIGIBLE TRANSACTION	Transaction was denied by host
DA(0)00900	INELIGIBLE ACCOUNT	Transaction was denied by host
DA(0)01000	DAILY LIMIT EXCEEDED	Transaction was denied by host
DA(0)01100	UNABLE TO PROCESS	Transaction was denied by host
DA(0)01200	Invalid transaction	Check the transaction from the host and try again.
DA(0)01300	Invalid amount	Check the transaction from the host and try again.
DA(0)01400	Invalid card number	Check the transaction from the host and try again.
DA(0)01500	UNABLE TO PROCESS	Transaction was denied by host
DA(0)01600	WITHDRAWAL LIMIT ALREADY REACHED	Transaction was denied by host
DA(0)01700	INVALID AMOUNT	Transaction was denied by host
DA(0)01800	EXTERNAL DECLINE	Transaction was denied by host

Error Code	Description	Trouble shooting
DA(0)01900	SYSTEM ERROR	Transaction was denied by host
DA(0)02000	Surcharge screen should have been displayed	Check the transaction from the host and try again. Check BIN List
DA(0)02100	ROUTING LOOKUP PROBLEM	Transaction was denied by host
DA(0)02200	UNABLE TO PROCESS	Transaction was denied by host
DA(0)02300	TRANSACTION NOT SUPPORTED	Transaction was denied by host
DA(0)02400	Exceeds Issuer Withdrawal Limit	Check the transaction from the host and try again.
DA(0)03900	No Credit Account	Check the transaction from the host and try again.
DA(0)05100	Insufficient Funds	Check the transaction from the host and try again. Try Balance Inquiry
DA(0)05200	No Checking Account	Check the transaction from the host and try again.
DA(0)05300	No Savings Account	Check the transaction from the host and try again.
DA(0)05400	Expire Card	Check the transaction from the host and try again.
DA(0)05500	Incorrect Pin	Check the transaction from the host and try again.
DA(0)05700	Transaction not Permitted – Card	Check the transaction from the host and try again.
DA(0)05800	Transaction not Permitted – Terminal	Check the transaction from the host and try again.
DA(0)06100	Exceeds Withdrawal Limit	Check the transaction from the host and try again.
DA(0)07500	PIN Tries Exceeded	Check the transaction from the host and try again.
DA(0)07800	No Account	Check the transaction from the host and try again.
DA(0)08000	Invalid Date	Check the transaction from the host and try again.

Error Code	Description	Trouble shooting
DA(0)08300	Can not Verify PIN	Check the transaction from the host and try again. Try different cards.
DA(0)08600	Can not Verify PIN	Check the transaction from the host and try again. Try different cards.
DA(0)09100	Bank Unavailable	Check the transaction from the host and try again.
DA(0)09200	System Unavailable	Check the transaction from the host and try again.
DA(0)09300	Transaction Serial Number mismatch	Check the terminal setting from the host.
DA(0)09400	Record format mismatch.	Check the terminal setting from the host.
DA(0)09500	Routing ID mismatch.	Check the terminal setting from the host.
DA(0)09600	Terminal ID mismatch.	Check the terminal setting from the host.
DA(0)09700	Response Type mismatch (Reversal)	Check the terminal setting from the host.
DA(0)09800	Response Type mismatch (Day Close)	Check the terminal setting from the host.
DA(0)09900	Response Type mismatch (Config.)	Check the terminal setting from the host.
DA(0)09A00	Response Type mismatch (Withdrawal/Balance/Transfer)	Check the terminal setting from the host.
DA(0)09B00	STX error	Check the terminal setting from the host.
DA(0)09C00	ETX error	Check the terminal setting from the host.
DA(0)09D00	FS out (after response code)	Check the terminal setting from the host.
DA(0)09E00	FS out (after retrieval reference number)	Check the terminal setting from the host.
DA(0)09F00	FS out (after system trace audit number)	Check the terminal setting from the host.
DA(0)0A000	FS out (after account balance)	Check the terminal setting from the host.

Error Code	Description	Trouble shooting
DA(0)0A100	FS out (after available balance)	Check the terminal setting from the host.
DA(0)0A200	FS out (after surcharge amount)	Check the terminal setting from the host.
DA(0)0A300	FS out (after authorization response text)	Check the terminal setting from the host.
DA(0)0A400	ETX wrong position	Check the terminal setting from the host.
DA(0)0A500	FS out (after total cash dispense amount)	Check the terminal setting from the host.
DA(0)0A600	FS out (after total non-cash dispense amount)	Check the terminal setting from the host.
DA(0)0A700	FS out (after total surcharge amount)	Check the terminal setting from the host.
DA(0)0A800	FS out (after config surcharge amount)	Check the terminal setting from the host.
DA(0)0A900	ETX out (config)	Check the terminal setting from the host.
DA(0)0AC00	Invalid data received from the host (MAC data mismatch)	Check the terminal setting from the host.
DA(0)0B000	TERMINAL ID MISMATCHED	
DA(0)0B100	TRANSACTION CODE MISMATCHED	
DA(0)0B200	SECOND FIELD ID CODE MISMATCHED	
DA(0)0B300	FIRST DES KEY WRONG SIZE	
DA(0)0B400	SURCHARGE AMOUNT WRONG SIZE	
DA(0)0B500	Sequence Number MISMATCHED	
DA(0)0B600	INVALID RESPONSE CODE ERROR	
DA(0)0B700	Authorization Number Error	
DA(0)0B800	BUSINESS DATE Error	
DA(0)0B900	Transaction time Number Error	
DA(0)0BA00	BUSINESS DATE Error	

Error Code	Description	Trouble shooting
DA(0)0BB00	Balance amount Error	
DA(0)0BC00	Actual Surcharge Error	
DA(0)0BD00	Sequence Number MISMATCHED	
DA(0)0BF00	BUSINESS DATE Error	
DA(0)0C000	Settlement Error	
DA(0)0C100	Host Mac result error	Check the key mode and MAC value
DA(0)0C200	ATM Mac result error	Check the key mode and MAC value
DA(0)11100	REVERSAL DECLINED	
DA(0)22200	PIN CHANGE DECLINED	
D100000	No connection	1. Check phone number 2. Check modem cable 3. Contact phone company
D110000	Cannot receive ENQ from the host	1. Check phone number 2. Check modem cable 3. Contact telephone company
D120000	Transmission error : Failed to receive the whole data within 5 seconds after requesting the modem to send the data.	1. Check modem and modem cable connection 2. Contact telephone company
D130000	Receiving NAK more than 3 times	1. Check modem and modem cable connection 2. Contact telephone company
D140100	Disconnected by Unknown Reason	1. Check modem and modem cable connection 2. Contact telephone company
D140200	Disconnected by rejected call from remote party	Try again later.
D140300	Disconnected because the local phone was picked up	Try again later.
D140400	Disconnected by Forwarded	1. Check modem and modem cable connection 2. Contact telephone company
D140500	Disconnected by Unreachable	1. Check modem and modem cable connection 2. Contact telephone company

Error Code	Description	Trouble shooting
D140600	Disconnected by Congestion	1. Check modem and modem cable connection 2. Contact telephone company
D140700	Disconnected by Incompatible	1. Check modem and modem cable connection 2. Contact telephone company
D140800	Disconnected by un-known reason	1. Check modem and modem cable connection 2. Contact telephone company
D140900	Disconnected by Bad Address	1. Check modem and modem cable connection 2. Contact telephone company
D141000	Disconnected by Unavailable	1. Check modem and modem cable connection 2. Contact telephone company
D150000	1. Modem dial connection time-out (while dialing the modem). 2. No response from host for 60 seconds.	1. Check modem and modem cable connection 2. Contact telephone company
D160100	Disconnected by Bad Address	1. Check modem and modem cable connection 2. Contact telephone company
D160200	Disconnected by Unavailable	1. Check modem and modem cable connection 2. Contact telephone company
D160300	Disconnected by Out of Order	1. Check modem and modem cable connection 2. Contact telephone company
D170000	No carrier (while sending/receiving data after dial connection)	Check host.
D170100	No Carrier during ENQ data receive from host	Check host.
D170200	No Carrier before sending data send to host	Check host.
D170300	No Carrier during sending data send to host	Check host.
D170400	No Carrier during ACK/NAK data send to host	Check host.
D170500	No Carrier during ACK/NAK data receive from host	Check host.
D170600	No Carrier during receiving data	Check host.

Error Code	Description	Trouble shooting
D170700	NAK retry error.	1. Check modem and modem cable connection 2. Contact telephone company
D170800	Send retry error	1. Check modem and modem cable connection 2. Contact telephone company
D170900	Modem initialize fail	Check modem
D171000	Modem Comport Failed	Check modem
D180000	No Dial Tone(in Modem dial connection)	Check telephone line connection. Test Modem.
D190000	No Answer	Contact telephone company (Check telephone line connection. Check phone number.)
D200000	Dial(Line) busy	Try again later. Check phone number.
D210000	Time out(30sec.) for initializing modem before Modem Dial connecting	Check telephone line connection. Test Modem.
D220000	not receiving EOT from HOST	Check telephone line connection. Test Modem. Check host.
D230000	No response from Host - Dialing time out to Host	Check telephone line connection. Test Modem. Check phone number.
D250000	Cannot connect to the host	Check telephone line connection
D251000	Timeout while Sending	Check telephone line connection
D251100	Communication error while Sending	Check telephone line connection
D251200	Socket error while Sending	Check telephone line connection
D251300	Timeout while Receiving	Check telephone line connection
D251400	Communication error while Receiving	Check telephone line connection
D251500	Socket Error while Receiving	Check telephone line connection
D320000	No response from Host/Dialing time out to Host	Check telephone line connection
D320100	Outbound call is aborted	Check telephone line connection. Test Modem.
D320200	Fail to dial out	Check telephone line connection. Test Modem.
D320300	No Line Reply	

Error Code	Description	Trouble shooting
D320400	Get Line ID Failed	
D320500	Modem Comport Failed	
D320600	Call Failed	
D320700	No Answer	
D320800	Modem Call Other Error	
D410000	CRC Mismatch	Check telephone line connection
D410100	No CRC Received	Make sure that the host is using CRC
DA0xxx0	Host Denial Error	
F000100	Number of Bill is not inputted	Enter number of bill. (required)
F000200	Parameter is not properly set (Surcharge Owner)	Enter surcharge owner. (required)
F000300	Parameter is not properly set (Surcharge Amount)	Enter surcharge amount. (required)
F000400	Parameter is not properly set (Adver. Text refreshing timer)	Enter Ad text refresh timer.
F000500	Parameter is not properly set (Advertisement text)	Enter Ad text.
F000600	Parameter is not properly set (Dispense limit)	Enter Dispense limit.
F000700	Parameter is not properly set (Denomination)	Enter Denomination. (required)
F000800	Parameter is not properly set (Fast Cash)	Enter Fast Cash amount.
F000900	Master Key Index invalid	Check Master key index.
F000A00	Master Key empty	Enter Master key. (required)
F000B00	Host Phone Number is not inputted	Enter Host phone number. (required)
F000C00	Error Retry Timer is not inputted	Enter Retry timer.
F000D00	RMS Password is not inputted in RMS Enable	Enter RMS password.

Error Code	Description	Trouble shooting
F000E00	RMS Phone Number is not inputted in RMS Enable	Enter RMS phone number.
F000F00	Terminal Number is not inputted	Enter Terminal number. (required)
F001000	Routing ID is not inputted	Enter Routing ID. (required)
F001100	Master Key Serial Number is not inputted	Enter Master key serial number.
F001200	Non-Cash Type text is not inputted	Enter Non-cash type text.
F001300	Parameter is not properly set	Check proper parameters in setting.
F001400	NVRAM Failure	Try to clear NVRAM
F001500	ATM Serial No. Empty	Enter ATM serial number. (required)
F001600	Default master password was not changed	
F001F00	Machine serial number is not set	Check serial number. 2. Set serial number.
F002F00	Host type is not set	Check host type. 2. Set host type.
F003F00	Communication ID invalid (only triton)	Contact to technician support team .
F004F00	EPP(Pinpad) key mode is invalid	1. Check modem cable 2. Contact to technician support team
F005F00	Denomination is invalid	1. Check modem cable 2. Contact to technician support team
F006F00	Failed Host Connection!	1. Check Host Connection. 2. Contact to technician support team.
F007F00	Invalid Exchange Rate	Download the exchange rate from RMS
F00FF00	Failed to write Journal	1.Back up journal to thumb drive 2.Clear journal 3.Reboot ATM
FFFFFFF	NVRAM is broken	1. Reset Master Password 2. Clear NVRAM

Error Code	Description	Trouble shooting
POWERAB	UPS ABNORMAL	Check UPS
POWERAC	POWER OUT OR AC OFF	Check AC power status and environment
POWERBA	BATTERY LOW	1. Check AC power status and environment 2. Check UPS
SDN0100	Service Panel (SPL) communication error	Check the cables and connections.

6) Description for error code organization

If an error occurs, you can understand cause of error through error code and help operator to judge situation. Below example is forms and contents for error code "5-40047(00)".

1. 5 in front "-" is procedure number, and you can analysis the procedure that an error occurs through that number.
 - 1) Procedure number, the number in front of "-", is none as follow situations :
 - (1) Reboot the system when errors occur:
 - (2) Fail to restore automatically when errors occur:
 - (3) When transferring from Operator Mode to In Service Mode not ruling out the error.
 - 2) "1" – After users insert the card, procedure number is 1.
 - 3) "3" – When sending message from ATM to Host, procedure number is 3.
 - 4) "5" – When receiving transaction success message from Host, procedure number is 5.
 - 5) "6" – After confirming notes during withdrawal, procedure number is 6.
 - 6) "9" – When receiving transaction refusal message from Host, procedure number is 9.
2. "40047(00)" back of "-" is a description for an error. (Refer to Error Code)
3. If an error occurs, below message will be displayed on the screen.

TERMINAL ID : XXXXXXXXXXXXXXXX
 ERROR CODE : 5-40047(00)
 ERROR DESCRPTION

☞ HOST DENIAL ERROR CODE

1. When receiving HOST DENY message, below error code will be displayed on the screen.

TERMINAL ID : XXXXXXXXXXXXXXXX
 ERROR CODE : 9- DA(0)0XX(X0)
 ERROR DESCRIPTION

-When HOST DENY ERROR CODE is 2 byte, DA(0)0XX(00) will be displayed.
 (Value of XX means denial code.)

- When HOST DENIAL ERROR CODE is 3 bytes, DA(0)0XX(X0) will be displayed.
 (Value of XXX means denial code.)

7.2 Installation Guide

7.2.1 Software Quick Installation Guide

- **Clear NVRAM**

(1) NVRAM

There are many important data in the NVRAM such as journal and configuration data.

To clear all of configuration and journal data to the initial status, clear NVRAM after S/W installation.

If you upgrade ATM operating in the field, you must backup journal and remember configuration information before clearing NVRAM.

(2) Clear NVRAM

1) Enter Supervisor Menu with Master Password



2) Select "SYSTEM SETUP" menu

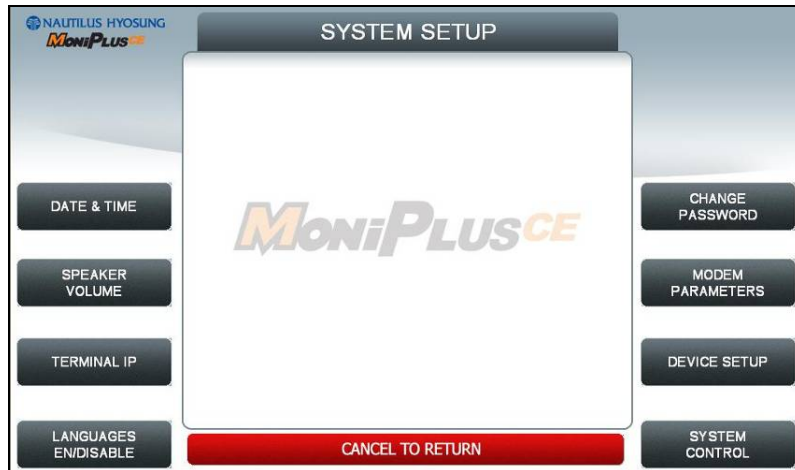

3) Select "SYSTEM CONTROL" menu



4) Select "CLEAR ALL" menu.



5) Confirm and select "Yes" menu.

6) All NVRAM data will be cleared and ATM will be automatically rebooted.

7.2.2 Installation Guide for NH-2700 / NH-1800SE

- DIAL-UP INITIAL SETTING

(1) DIAL-UP SETTING

1) Input Master password to enter main screen.



2) Select "HOST SETUP" menu.



3) Select "TELEPHONE NUMBER" menu.



4) Be sure to input the telephone numbers both in the HOST PHONE #1 and in the HOST PHONE #2 after selecting "HOST PHONE #1" and "HOST PHONE #2" menu and click 'ENTER' on the pinpad.

5) After above procedures, press **IN SERVICE** button or '1' key on the pinpad in the main screen.

● TCP/IP INITIAL SETTING

(1) TCP/IP SETTING

1) Input Master password to enter main screen.



2) Select "CUSTOMER SETUP" menu.

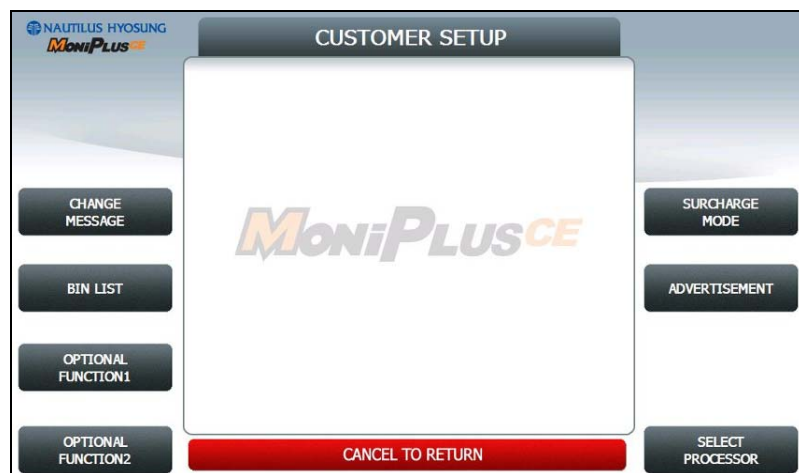

3) Select "SELECT PROCESSOR" menu.

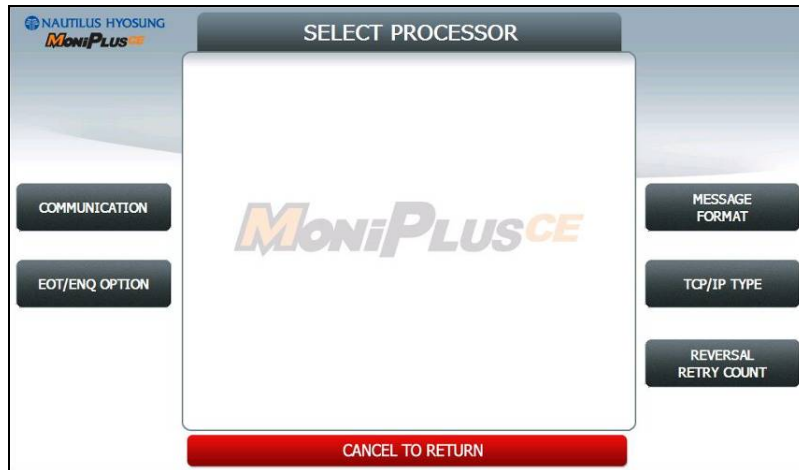

4) Select "COMMUNICATION" menu.



5) Select "TCP/IP" menu and message in the COMMUNICATION box will be changed from DIALUP to TCP/IP.

6) Click 'CANCEL' button and SELECT PROCESSOR screen will be back.

7) Select "MESSAGE FORMAT" menu in the SELECT PROCESSOR screen.

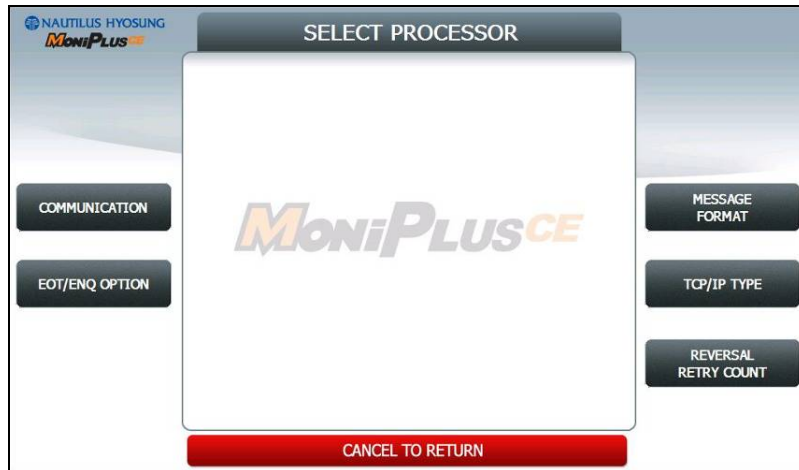

8) Select "STANDARD1" menu in the MESSAGE FORMAT screen. Click 'CANCEL' button to go SELECT PROCESSOR screen.



- 9) Select "TCPIP TYPE" menu in the SELECT HOST screen.
- 10) Set "STANDARD" in the TCP/IP TYPE menu and set DISABLE in the SSL OPTION menu. Click 'CANCEL' button to go SELECT PROCESSOR screen.

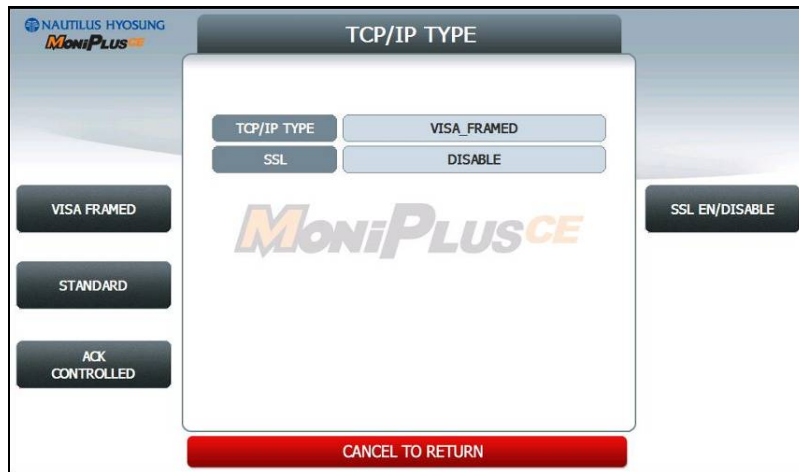

- 11) Click 'CANCEL' button and CUSTOMER SETUP screen will be shown. Click 'CANCEL' button once more to go to the OP MAIN screen. And select "SYSTEM SETUP" menu.



- 12) Select "TERMINAL IP" menu.

13) Set "DHCP EN/DISABLE" as DISABLE to activate buttons related with "STATIC IP"

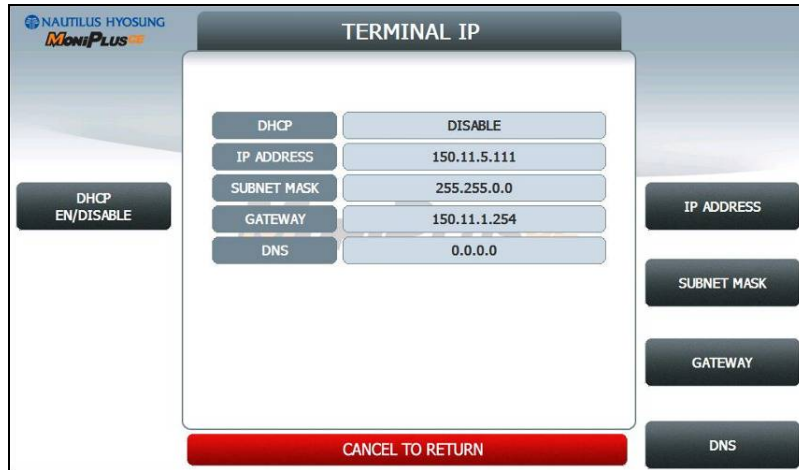

14) Select "IP ADDRESS", "GATEWAY", "SUBNET MASK" and "DNS" and set the input values individually.

15) Select "HOST SETUP" menu in the OP MAIN screen.

16) Select "HOST ADDRESS" menu in the HOST SETUP screen.



17) Select "URL EN/DISABLE" menu in the HOST ADDRESS screen.

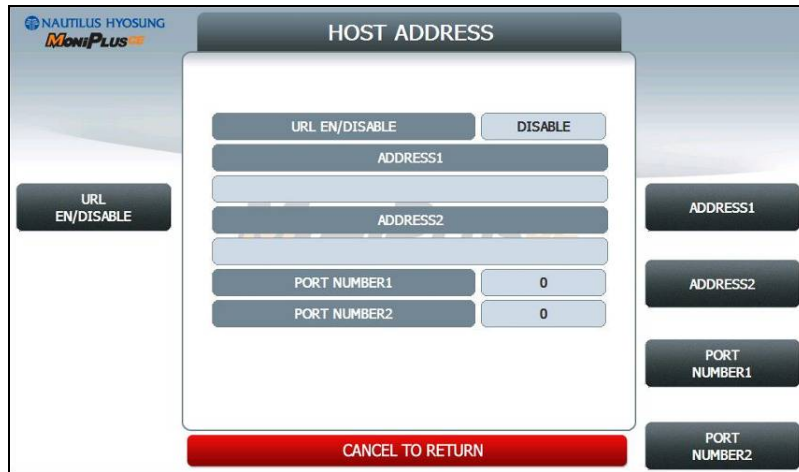

18) Select "HOST ADDRESS 1", "PORT NUMBER 1", "HOST ADDRESS 2", "PORT NUMBER 2" in the HOST ADDRESS screen and set input values individually.

19) After finishing all setting up, press **IN SERVICE** button '1' or **CANCEL** key on the pinpad in the main screen. Then ATM will be rebooted automatically with the "REBOOTING" message shown.

7.3 Transaction Screen Flow

This chapter shows you the demonstration screen for NH-1800SE.

7.3.1 TRANSACTION PROCESS (ENGLISH)

7.3.1.1 AP MAIN

This is a main AP screen and the customer can start to do transaction by inserting and quickly removing the card on card reader.

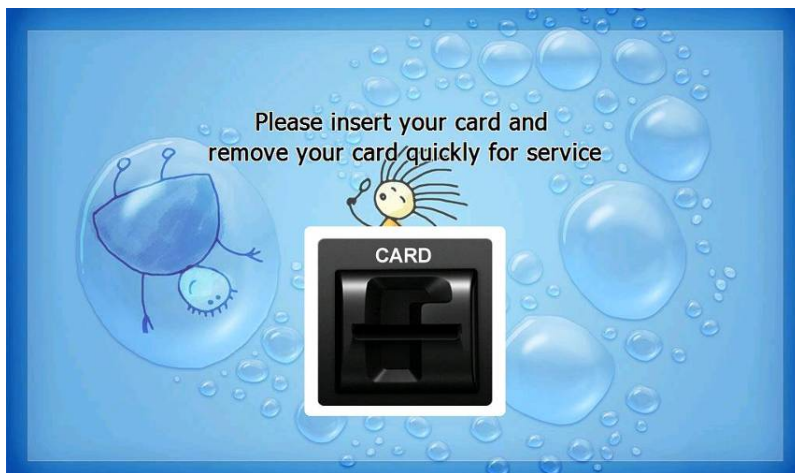

7.3.1.2 SELECT LANGUAGE

Language a customer would like to use in transaction can be selected in this screen.



[Function Key Type]



[Touch Type]

7.3.1.3 ENTER PIN

This screen is to enter PIN of customer's card



7.3.1.4 SELECT TRANSACTION

This screen is to select transaction type the customer wants to transact such as withdrawal, balance inquiry and transfer is selected in this screen.



[Function Key Type]



[Touch Type]

7.3.1.4.1 WITHDRAWAL: FEE NOTICE

This screen is to show a customer the information of surcharge.

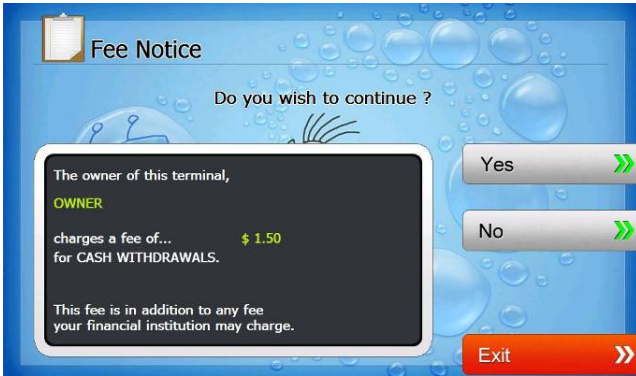

[Function Key Type]

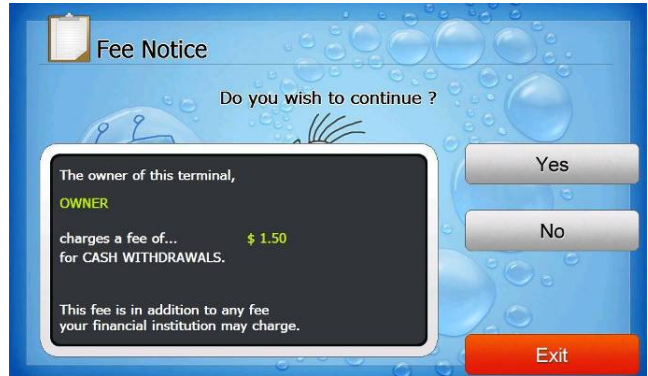

[Touch Type]

7.3.1.4.2 WITHDRAWAL: SELECT RECEIPT PRINTING OR NOT

This screen is to ask a customer if he/she wants to get the receipt or not.



[Function Key Type]



[Touch Type]

7.3.1.4.3 WITHDRAWAL: SELECT ACCOUNT (Checking, Saving, Credit Card)

This screen is to ask a customer where he/she wants to withdraw in checking, saving, credit card



[Function Key Type]



[Touch Type]

7.3.1.4.4 WITHDRAWAL: SELECT THE AMOUNT OF WITHDRAWAL

This screen is to select the amount of withdrawal. If there is not any amount to withdraw, please select the "OTHER" key and can input the amount the customer would like to withdraw.

1) Amount Selection



[Function Key Type]



[Touch Type]

2) Amount Input (Other)

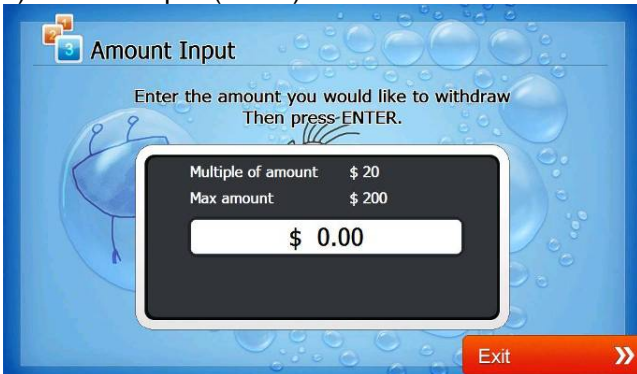

[Function Key Type]



[Touch Type]

7.3.1.4.5 WITHDRAWAL: CONNECTING HOST

This screen is to show the customer that the transaction is in progress.

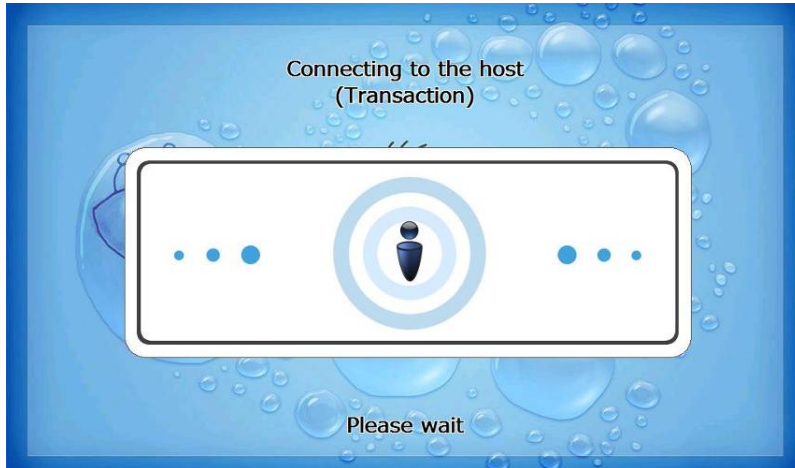

7.3.1.4.6 WITHDRAWAL: DISPENSING MONEY AND TAKE MONEY

This screen is to show the customer that his/her request amount is dispensing and to notify the customer to take his/her money.



7.3.1.4.7 WITHDRAWAL: PRINTING TRANSACTION AND TAKE RECEIPT

This screen is to show the customer that his/her transaction record is printing and to notify the customer to take his/her receipt.

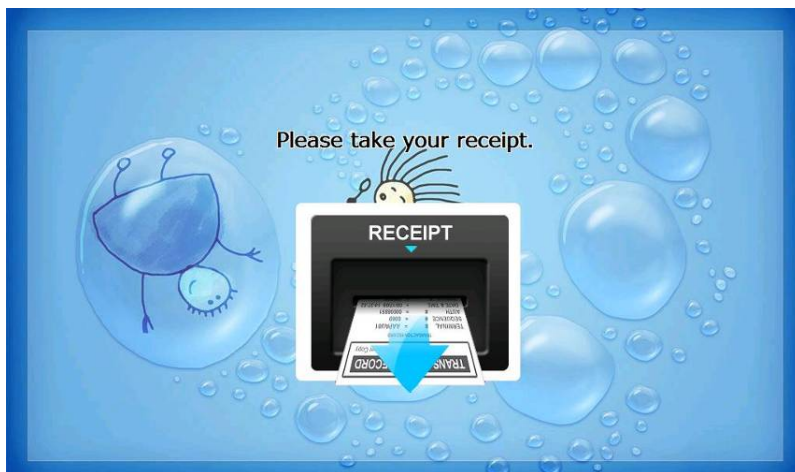
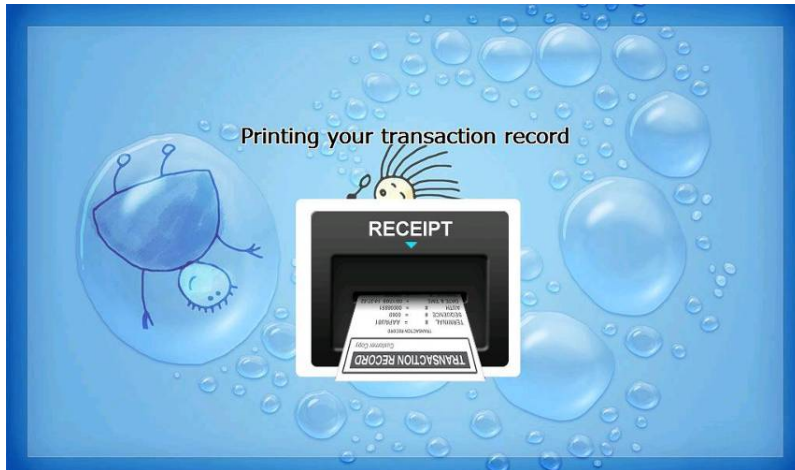

7.3.1.4.8 WITHDRAWAL: THANK YOU

This screen is to show the customer that the transaction has been successfully completed.

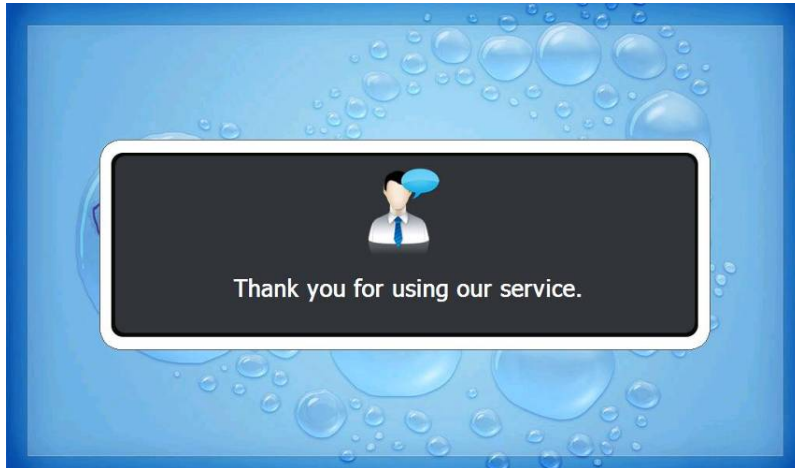

7.3.1.4.9 TRANSFER: SELECT RECEIPT PRINTING OR NOT

This screen is to ask a customer if he/she gets the receipt or not.



[Function Key Type]



[Touch Type]

7.3.1.4.10 TRANSFER: SELECT ACCOUNT TO TRANSFER FROM

This screen is to ask a customer where he/she wants to transfer from; checking, saving, credit card



[Function Key Type]



[Touch Type]

7.3.1.4.11 TRANSFER: SELECT ACCOUNT TO TRANSFER TO

This screen is to ask a customer where he/she wants to transfer to; checking, saving, credit card



[Function Key Type]



[Touch Type]

7.3.1.4.12 TRANSFER: ENTER TRANSFER AMOUNT

This screen is to select the amount of transfer.

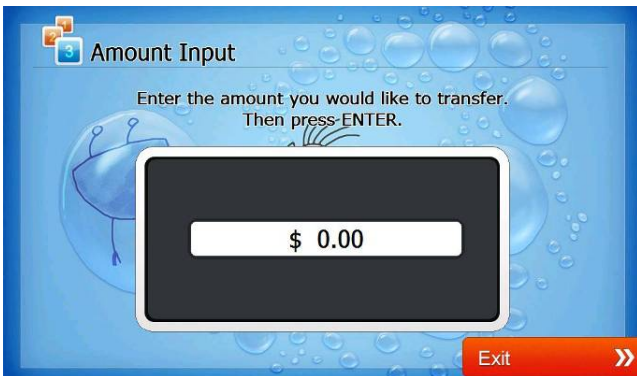

[Function Key Type]

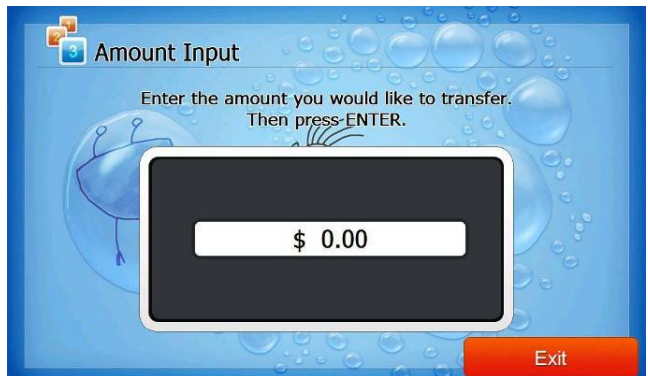

[Touch Type]

7.3.1.4.13 TRANSFER: CONNECTING HOST

This screen is to show the customer that the transaction is in progress.

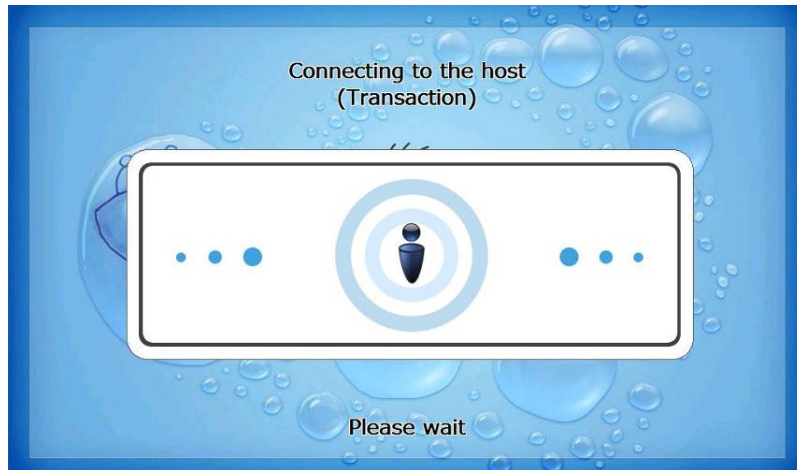

7.3.1.4.14 TRANSFER: PRINTING TRANSACTION AND TAKE RECEIPT

This screen is to show the customer that his/her transaction record is printing and to notify the customer to take his/her receipt.

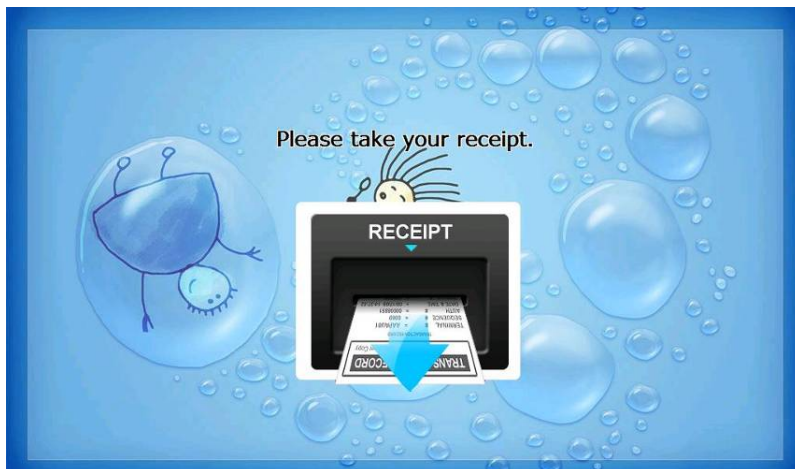
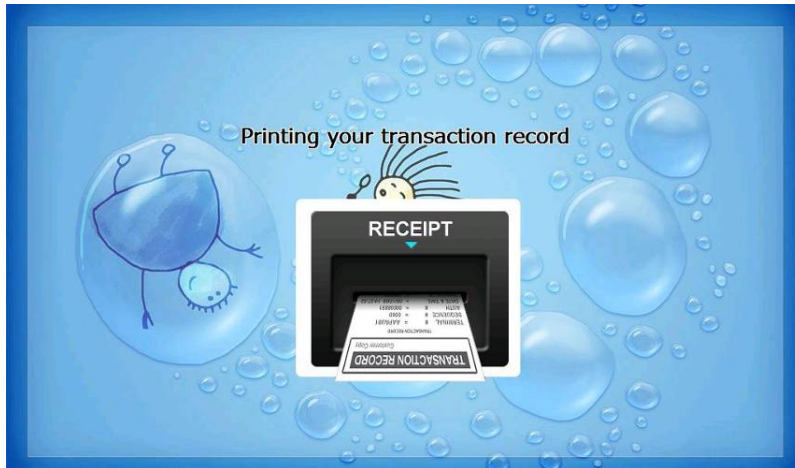

7.3.1.4.15 TRANSFER: THANK YOU

This screen is to show the customer that the transaction has been successfully completed.

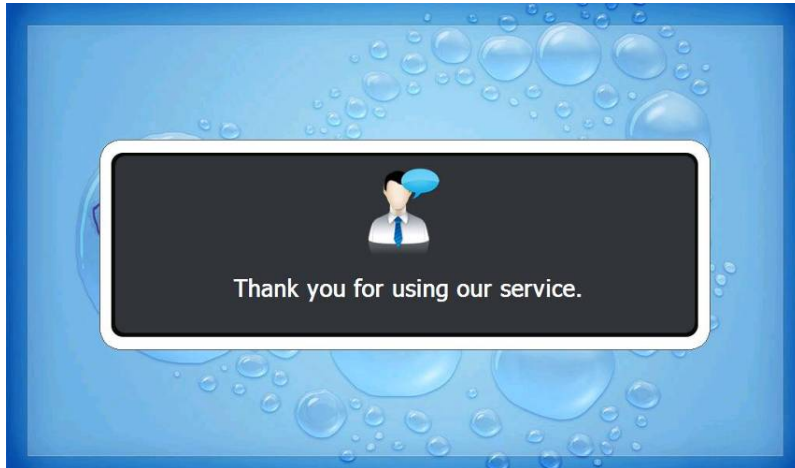

7.3.1.4.16 INQUIRY: SELECT RECEIPT PRINTING OR NOT

This screen is to ask a customer if he/she wants to get the receipt or not.



[Function Key Type]



[Touch Type]

7.3.1.4.17 INQUIRY: SELECT ACCOUNT TO INQUIRE

This screen is to ask a customer which account he/she wants to inquire



[Function Key Type]



[Touch Type]

7.3.1.4.18 INQUIRY: CONNECTING HOST

This screen is to show the customer that the transaction is in progress.

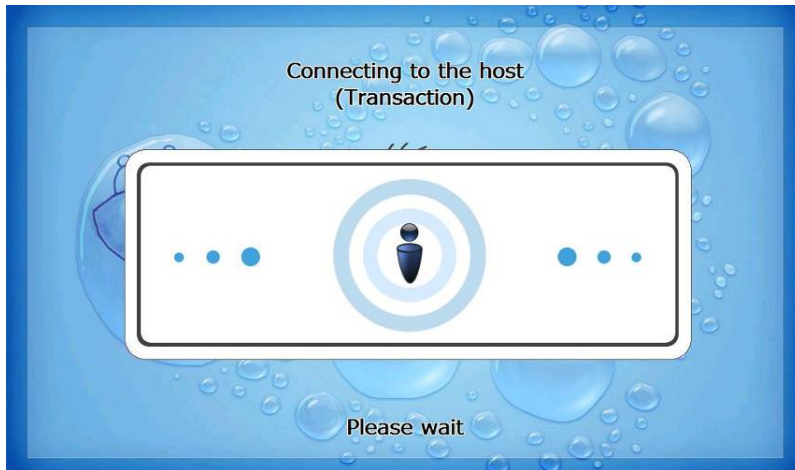

7.3.1.4.19 INQUIRY: PRINTING TRANSACTION AND TAKE RECEIPT

This screen is to show the customer that his/her transaction record is printing and to notify the customer to take his/her receipt.

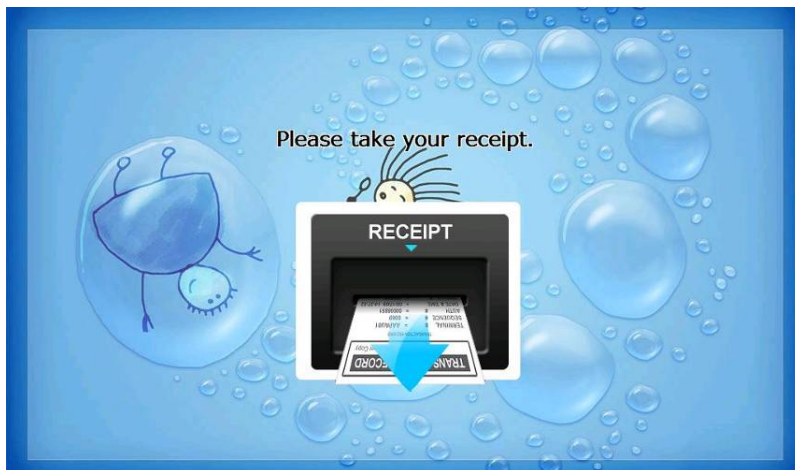
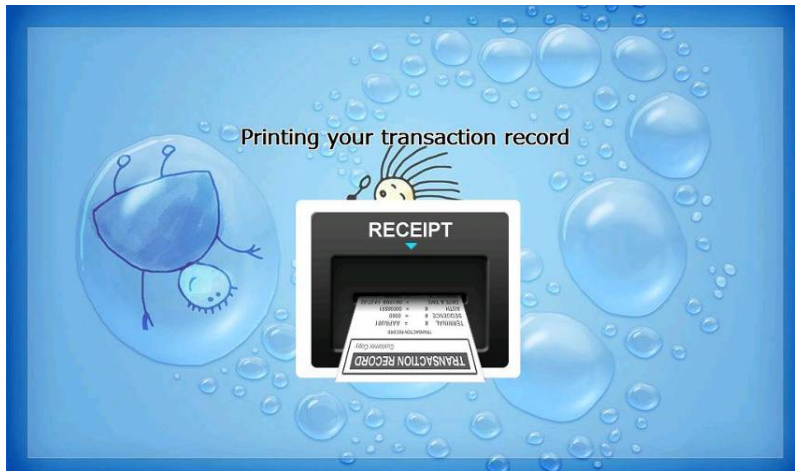

7.3.1.4.20 INQUIRY: THANK YOU

This screen is to show the customer that the transaction has been successfully completed.

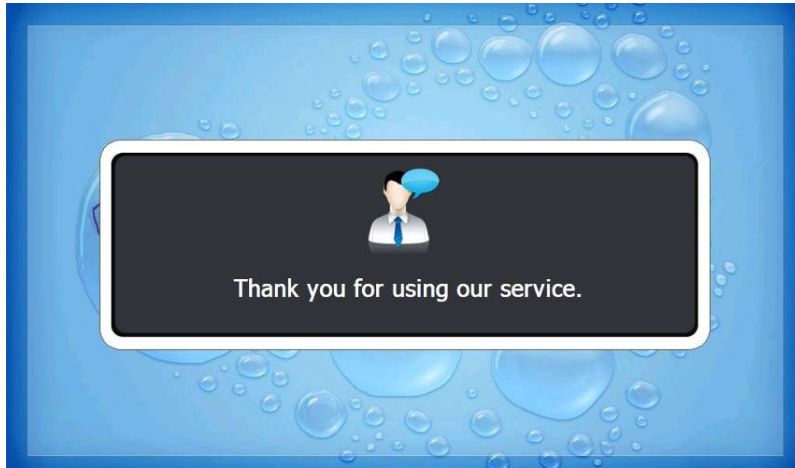

7.3.2 TRANSACTION PROCESS (SPANISH)

7.3.2.1 AP MAIN

This is a main AP screen and the customer can start to do transaction by inserting and quickly removing the card on card reader.



7.3.2.2 SELECT LANGUAGE

Language a customer would like to use in transaction can be selected in this screen.



[Function Key Type]



[Touch Type]

7.3.2.3 Enter PIN

This screen is to enter PIN of customer's card



7.3.2.4 SELECT TRANSACTION

This screen is to select transaction type the customer wants to transact such as withdrawal, balance inquiry and transfer is selected in this screen.



[Function Key Type]



[Touch Type]

7.3.2.4.1 WITHDRAWAL: FEE NOTICE

This screen is to show a customer the information of surcharge.

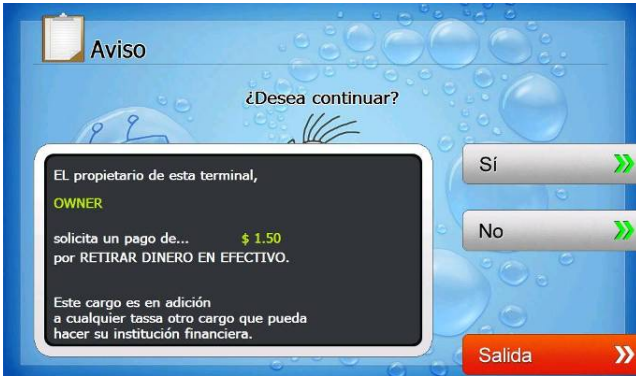

[Function Key Type]

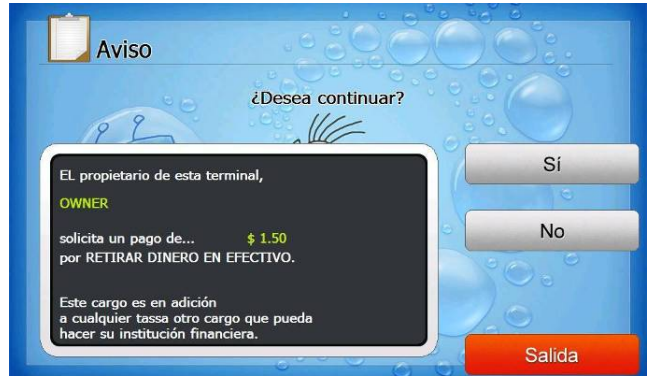

[Touch Type]

7.3.2.4.2 WITHDRAWAL: SELECT RECEIPT PRINTING OR NOT

This screen is to ask a customer if he/she wants to get the receipt or not.



[Function Key Type]



[Touch Type]

7.3.2.4.3 WITHDRAWAL: SELECT ACCOUNT (Checking, Saving, Credit Card)

This screen is to ask a customer where he/she wants to withdraw in checking, saving, credit card



[Function Key Type]



[Touch Type]

7.3.2.4.4 WITHDRAWAL: SELECT THE AMOUNT OF WITHDRAWAL

This screen is to select the amount of withdrawal. If there is not any amount to withdraw, please select the "OTHER" key and can input the amount the customer would like to withdraw.

1) Amount Selection



[Function Key Type]



[Touch Type]

2) Amount Input (Other)

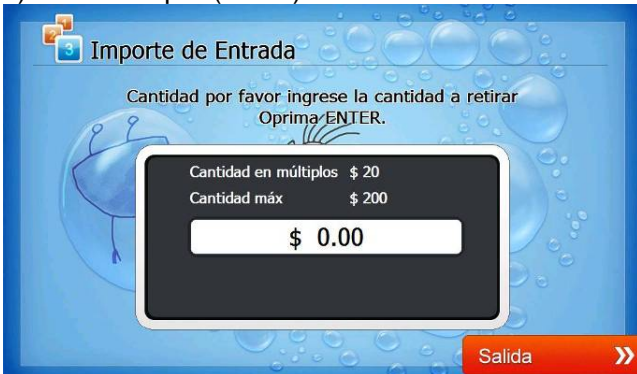

[Function Key Type]



[Touch Type]

7.3.2.4.5 WITHDRAWAL: CONNECTING HOST

This screen is to show the customer that the transaction is in progress.



7.3.2.4.6 WITHDRAWAL: DISPENSING MONEY AND TAKE MONEY

This screen is to show the customer that his/her request amount is dispensing and to notify the customer to take his/her money.



7.3.2.4.7 WITHDRAWAL: PRINTING TRANSACTION AND TAKE RECEIPT

This screen is to show the customer that his/her transaction record is printing and to notify the customer to take his/her receipt.



7.3.2.4.8 WITHDRAWAL: THANK YOU

This screen is to show the customer that the transaction has been successfully completed.



7.3.2.4.9 TRANSFER: SELECT RECEIPT PRINTING OR NOT

This screen is to ask a customer if he/she gets the receipt or not.



[Function Key Type]



[Touch Type]

7.3.2.4.10 TRANSFER: SELECT ACCOUNT TO TRANSFER FROM

This screen is to ask a customer where he/she wants to transfer from; checking, saving, credit card



[Function Key Type]



[Touch Type]

7.3.2.4.11 TRANSFER: SELECT ACCOUNT TO TRANSFER TO

This screen is to ask a customer where he/she wants to transfer to; checking, saving, credit card



[Function Key Type]



[Touch Type]

7.3.2.4.12 TRANSFER: ENTER TRANSFER AMOUNT

This screen is to select the amount of transfer.



[Function Key Type]

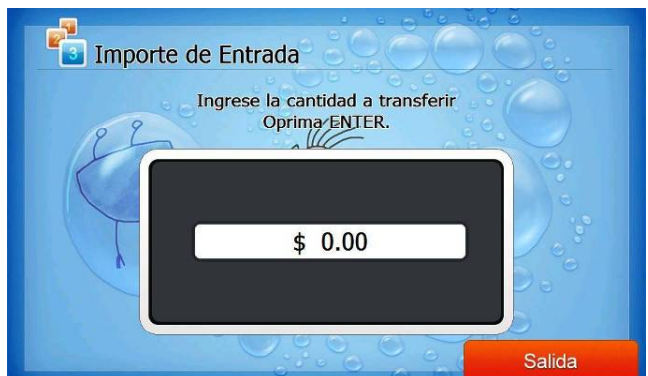

[Touch Type]

7.3.2.4.13 TRANSFER: CONNECTING HOST

This screen is to show the customer that the transaction is in progress.



7.3.2.4.14 TRANSFER: PRINTING TRANSACTION AND TAKE RECEIPT

This screen is to show the customer that his/her transaction record is printing and to notify the customer to take his/her receipt.



7.3.2.4.15 TRANSFER: THANK YOU

This screen is to show the customer that the transaction has been successfully completed.



7.3.2.4.16 INQUIRY: SELECT RECEIPT PRINTING OR NOT

This screen is to ask a customer if he/she wants to get the receipt or not.



[Function Key Type]



[Touch Type]

7.3.2.4.17 INQUIRY: SELECT ACCOUNT TO INQUIRE

This screen is to ask a customer which account he/she wants to inquire



[Function Key Type]



[Touch Type]

7.3.2.4.18 INQUIRY: CONNECTING HOST

This screen is to show the customer that the transaction is in progress.



7.3.2.4.19 INQUIRY: PRINTING TRANSACTION AND TAKE RECEIPT

This screen is to show the customer that his/her transaction record is printing and to notify the customer to take his/her receipt.



7.3.2.4.20 INQUIRY: THANK YOU

This screen is to show the customer that the transaction has been successfully completed.



7.3.3 TRANSACTION PROCESS (FRENCH)

7.3.3.1 AP MAIN

This is a main AP screen and the customer can start to do transaction by inserting and quickly removing the card on card reader.



7.3.3.2 SELECT LANGUAGE

Language a customer would like to use in transaction can be selected in this screen.



[Function Key Type]



[Touch Type]

7.3.3.3 Enter PIN

This screen is to enter PIN of customer's card



7.3.3.4 SELECT TRANSACTION

This screen is to select transaction type the customer wants to transact such as withdrawal, balance inquiry and transfer is selected in this screen.



[Function Key Type]



[Touch Type]

7.3.3.4.1 WITHDRAWAL: FEE NOTICE

This screen is to show a customer the information of surcharge.



[Function Key Type]

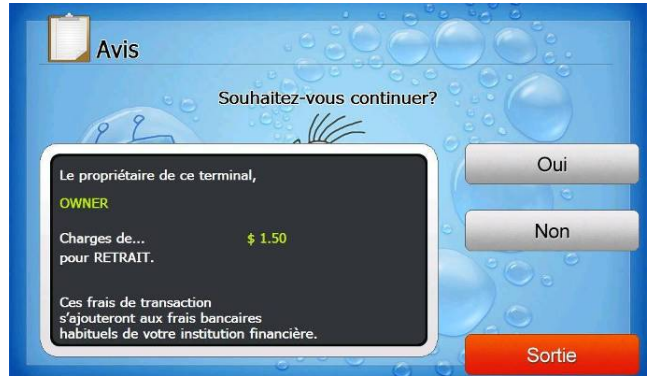

[Touch Type]

7.3.3.4.2 WITHDRAWAL: SELECT RECEIPT PRINTING OR NOT

This screen is to ask a customer if he/she wants to get the receipt or not.



[Function Key Type]



[Touch Type]

7.3.3.4.3 WITHDRAWAL: SELECT ACCOUNT (Checking, Saving, Credit Card)

This screen is to ask a customer where he/she wants to withdraw in checking, saving, credit card



[Function Key Type]



[Touch Type]

7.3.3.4.4 WITHDRAWAL: SELECT THE AMOUNT OF WITHDRAWAL

This screen is to select the amount of withdrawal. If there is not any amount to withdraw, please select the “OTHER” key and can input the amount the customer would like to withdraw.

1) Amount Selection



[Function Key Type]



[Touch Type]

2) Amount Input (Other)



[Function Key Type]



[Touch Type]

7.3.3.4.5 WITHDRAWAL: CONNECTING HOST

This screen is to show the customer that the transaction is in progress.

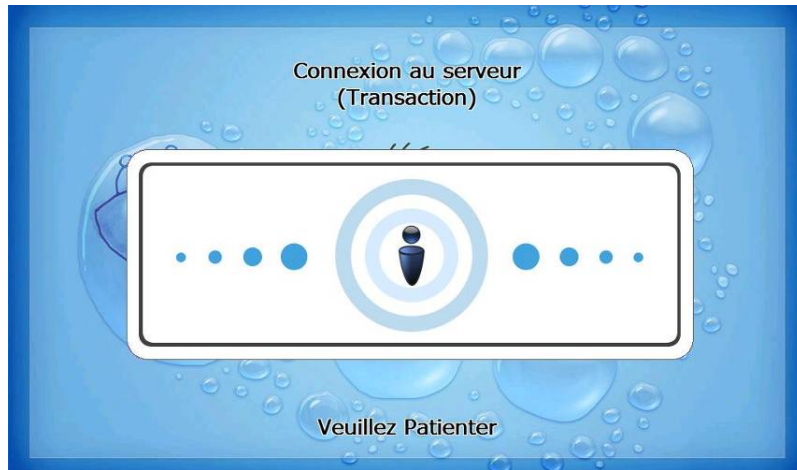

7.3.3.4.6 WITHDRAWAL: DISPENSING MONEY AND TAKE MONEY

This screen is to show the customer that his/her request amount is dispensing and to notify the customer to take his/her money.



7.3.3.4.7 WITHDRAWAL: PRINTING TRANSACTION AND TAKE RECEIPT

This screen is to show the customer that his/her transaction record is printing and to notify the customer to take his/her receipt.



7.3.3.4.8 WITHDRAWAL: THANK YOU

This screen is to show the customer that the transaction has been successfully completed.



7.3.3.4.9 TRANSFER: SELECT RECEIPT PRINTING OR NOT

This screen is to ask a customer if he/she gets the receipt or not.



[Function Key Type]



[Touch Type]

7.3.3.4.10 TRANSFER: SELECT ACCOUNT TO TRANSFER FROM

This screen is to ask a customer where he/she wants to transfer from; checking, saving, credit card



[Function Key Type]



[Touch Type]

7.3.3.4.11 TRANSFER: SELECT ACCOUNT TO TRANSFER TO

This screen is to ask a customer where he/she wants to transfer to; checking, saving, credit card



[Function Key Type]



[Touch Type]

7.3.3.4.12 TRANSFER: ENTER TRANSFER AMOUNT

This screen is to select the amount of transfer.



[Function Key Type]



[Touch Type]

7.3.3.4.13 TRANSFER: CONNECTING HOST

This screen is to show the customer that the transaction is in progress.

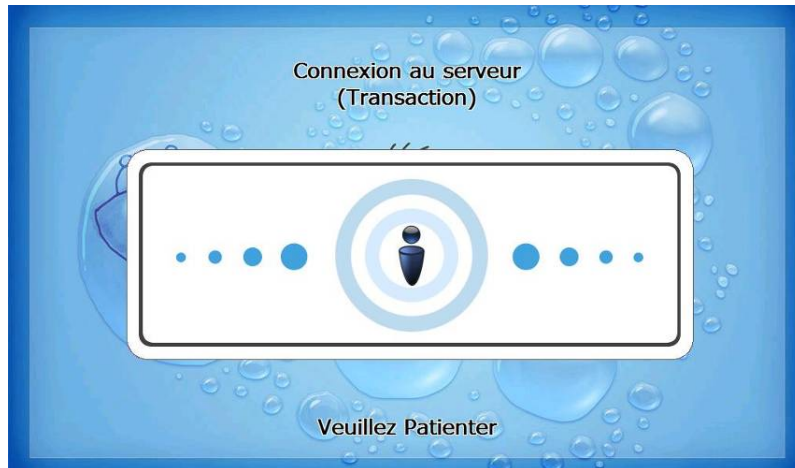

7.3.3.4.14 TRANSFER: PRINTING TRANSACTION AND TAKE RECEIPT

This screen is to show the customer that his/her transaction record is printing and to notify the customer to take his/her receipt.



7.3.3.4.15 TRANSFER: THANK YOU

This screen is to show the customer that the transaction has been successfully completed.



7.3.3.4.16 INQUIRY: SELECT RECEIPT PRINTING OR NOT

This screen is to ask a customer if he/she wants to get the receipt or not.



[Function Key Type]



[Touch Type]

7.3.3.4.17 INQUIRY: SELECT ACCOUNT TO INQUIRE

This screen is to ask a customer which account he/she wants to inquire



[Function Key Type]



[Touch Type]

7.3.3.4.18 INQUIRY: CONNECTING HOST

This screen is to show the customer that the transaction is in progress.

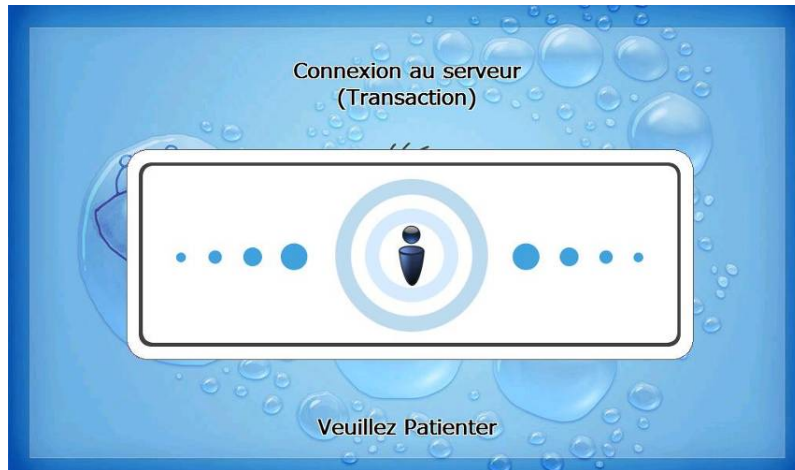

7.3.3.4.19 INQUIRY: PRINTING TRANSACTION AND TAKE RECEIPT

This screen is to show the customer that his/her transaction record is printing and to notify the customer to take his/her receipt.



7.3.3.4.20 INQUIRY: THANK YOU

This screen is to show the customer that the transaction has been successfully completed.



7.4 Supported USB Memory and HUB

7.4.1 USB Memory

7.4.1.1 Supported USB Memory

No.	Vendor	Modem Model	Memory	Remarks
1	Sony Corporation (VID:0x054C)	Storage Media (PID:0x0243)	512MB	
2	SMI Corportation (VID:0x090C)	USB Disk (PID:0x1000)	512MB	
3	Kingston (VID:0x0951)	Data Traveler (PID:0x1603)	512MB	
4	pq1 (VID:0x3538)	USB Mass Storage Device (PID:0x0042)	512MB	
5	LEXAR Media (VID:0x05DC)	JD FIREFLY (PID:0A560)	1GB	
6	LG (VID:0x090C)	USB Driver (PID:0x1000)	1GB	
7	Memorex (VID:0x12F7)	TD Classic 003B (PID:0x1A00)	1GB	

☞ VID : Vendor ID, PID : Product ID

7.4.1.2 Supported Memory Specifications

- 1) File System: FAT
- 2) Number of supported drivers: 1
- 3) Memory: 2GB or below

☞ Example : 1) SANDisk 512MB is not supported because it has 2 file systems.
(CDFS and FAT)

2) Sony Storage Media is supported because it is FAT, 1 driver and 512 MB size.

7.4.2 Supported USB HUB Types

No.	Vendor	Modem Model	VID(HUB CHIP Vendor)	PID
1	Macsense Connectivity	UH-Mini4i	0x05E3(Genesys Logics inc)	0x0606
2	INLAND	Inland USB2.0 HUB	0x0409(NEC Corporation)	0x005A
3	VAKO International Inc	USB 2.0 Aluminum HUB	0x05E3(Genesys Logics inc)	0x0606
4	PPA Int'l	I.Connector(PPA 4Port HUB)	0x05E3(Genesys Logics inc)	0x0606
5	ZIO	USB 2040 Mini	0x05E3(Genesys Logics inc)	0x0606
6	DSP Inc	E-Star QU24WR	0x05E3(Genesys Logics inc)	0x0606

7.5 Advertisement Image Update Guide

7.5.1 Preparation

Software Update function in Nautilus Hyosung's Windows CE Machine is applicable to update advertisement images.

7.5.1.1 Supported Image Format

The following table describe the supporting format of welcome advertisement image

Model	Image Size	DPI	Color	File Format	Max Size (one image)
NH-2700	1024 X 600	72	24bit color	JPEG	300KB
NH-1800SE	800 X 600	72	24bit color	JPEG	300KB

The following table describe the supporting format of transaction advertisement image

Model	Image Size	DPI	Color	File Format	Max Size (one image)
NH-2700	690 X 225	72	24bit color	JPEG	160KB
NH-1800SE	690 X 225	72	24bit color	JPEG	160KB

The following table describe the file name and path of advertisement images. The path in blow table indicates image size is 1024 X 600 (NH2700) / 800 X 600 (NH1800SE)

Welcome Advertisement	File Name	Path
Screen #1	Adv_01.jpg	\ATM\Advertisement\1024_600 (NH2700) \ATM\Advertisement\800_600 (NH1800SE)
Screen #2	Adv_02.jpg	\ATM\Advertisement\1024_600 (NH2700) \ATM\Advertisement\800_600 (NH1800SE)
Screen #3	Adv_03.jpg	\ATM\Advertisement\1024_600 (NH2700) \ATM\Advertisement\800_600 (NH1800SE)
Screen #4	Adv_04.jpg	\ATM\Advertisement\1024_600 \ATM\Advertisement\800_600 (NH1800SE)
Screen #5	Adv_05.jpg	\ATM\Advertisement\1024_600 (NH2700) \ATM\Advertisement\800_600 (NH1800SE)
Screen #6	Adv_06.jpg	\ATM\Advertisement\1024_600 (NH2700) \ATM\Advertisement\800_600 (NH1800SE)

Transaction Advertisement	File Name	Path
Screen #1	TranAdv_01.jpg	\ATM\Advertisement\1024_600 (NH2700) \ATM\Advertisement\800_600 (NH1800SE)
Screen #2	TranAdv_02.jpg	\ATM\Advertisement\1024_600 (NH2700) \ATM\Advertisement\800_600 (NH1800SE)
Screen #3	TranAdv_03.jpg	\ATM\Advertisement\1024_600 (NH2700) \ATM\Advertisement\800_600 (NH1800SE)
Screen #4	TranAdv_04.jpg	\ATM\Advertisement\1024_600 (NH2700) \ATM\Advertisement\800_600 (NH1800SE)
Screen #5	TranAdv_05.jpg	\ATM\Advertisement\1024_600 (NH2700) \ATM\Advertisement\800_600 (NH1800SE)
Screen #6	TranAdv_06.jpg	\ATM\Advertisement\1024_600 (NH2700) \ATM\Advertisement\800_600 (NH1800SE)

7.5.1.2 Updating your own UpdateInfo.dat (Optional)

Advertisement images are updated using the software update program. While updating program proceeds, a line of message shows up in the main screen. If you want to change the message, just edit UpdateInfo.dat. The message length is up to 40 characters. A sample content is as follows. You can replace “A sample message.(V1.21)” to your own message.

A sample message. (V1.21)

UpdateInfo.dat

7.5.1.3 Making SW Update media

- 1) Make "UPDATE" folder in the USB memory drive or the SD Card.
- 2) Make "NH2700CE" folder in the "UPDATE" folder.
- 3) Make "PATCH" folder in the "NH2700CE" folder.
- 4) Copy "UpdateInfo.dat" to under "PATCH" folder. (Optional)
- 5) Make "ADVERTISEMENT" folder in the "PATCH" folder.
- 6) Make "1024_600"(NH2700) / "800_600"(NH1800SE) folder in "ADVERTISEMENT" folder.
- 7) Copy all image files to under "1024_600" / "800_600" folder.(check the file name)

The following picture describes the layout of the USB Drive or SD Card.

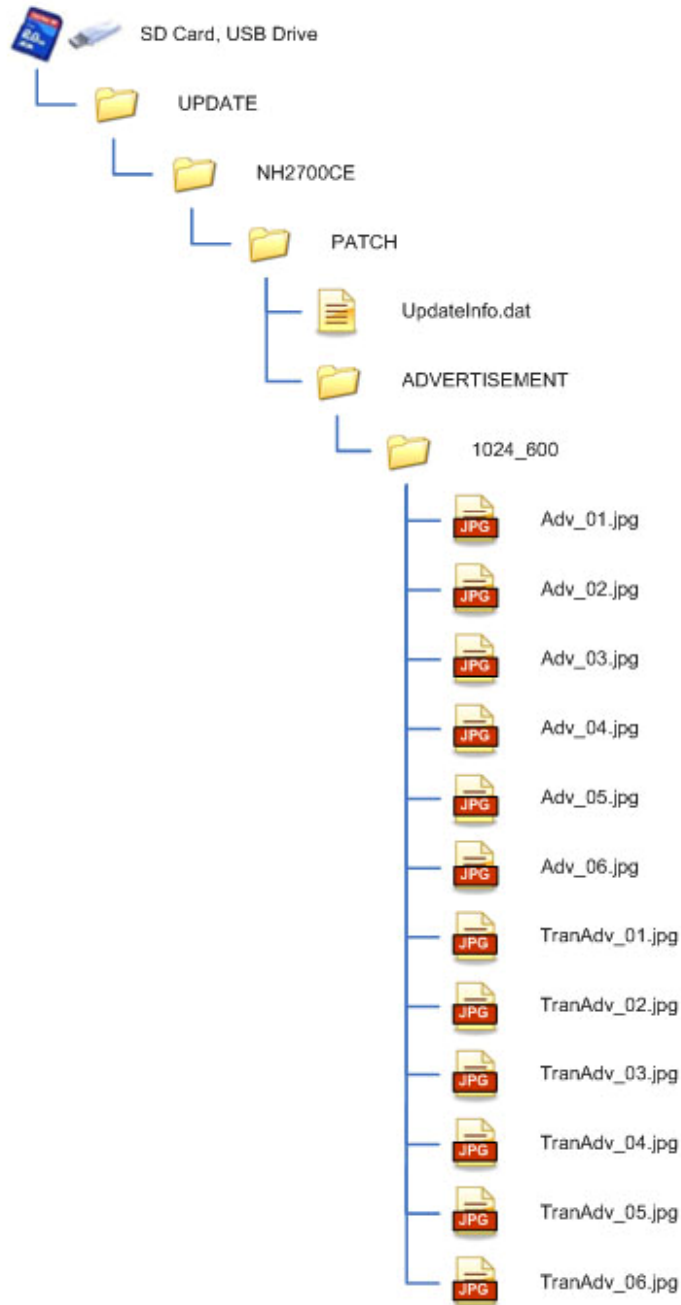

(If you have NH1800SE, you can see the same layout except “1024_600” folder. “1024_600” folder is replaced “800_600” folder.)

7.5.2 Execute updating

7.5.2.1 Software Update

Advertisement images can be installed or updated by Software Update tool in supervisor menu. You can update advertisement images by software downloading with MoinView server. Please refer to the MoinView manual for the detail downloading functionality.

1) Press SYSTEM SETUP button.



2) Press SYSTEM CONTROL button.

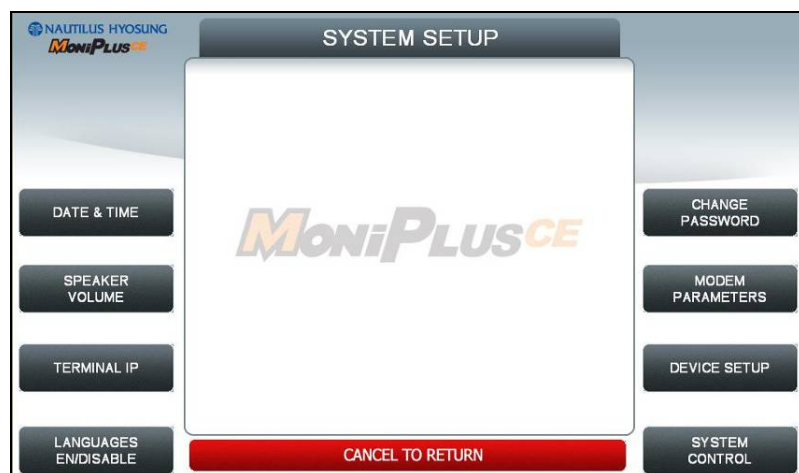

3) Plug the USB drive in USB slot and press left-top function key, "SOFTWARE UPDATE".



4) Press left function key, "YES".

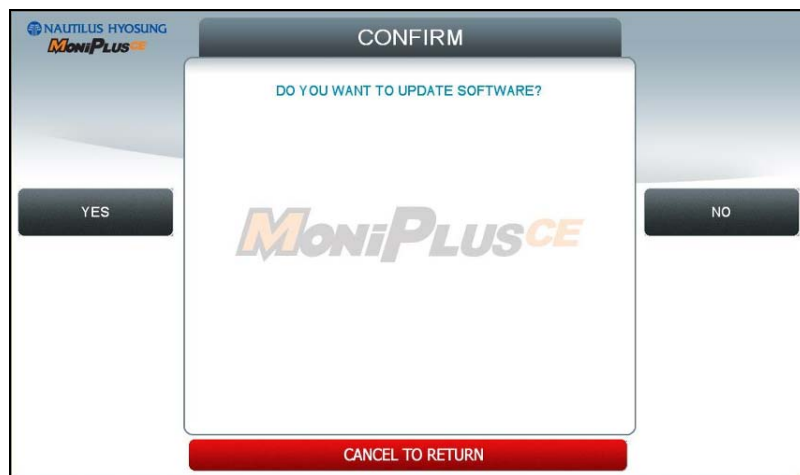

When "YES" button is selected, new software in USB drive is transferred to a dedicated directory(ATM) and ATM will start to reboot automatically.

7.5.2.2 Enable Welcome Advertisement

You can enable or disable Welcome Advertisement in the supervisor menu.



1) Press CUSTOMER SETUP button

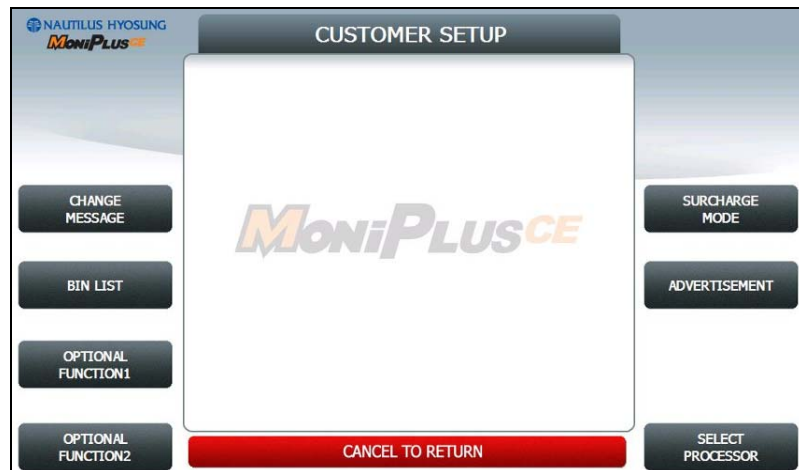

2) Press "WELCOME ADVERTISEMENT" button



3) Press "WELCOME ADVERTISEMENT" button



4) You can enable or disable Advertisement images to view by pressing "SCREEN" Key.



7.5.2.3 Enable Transaction Advertisement

You can enable or disable Transaction Advertisement in the supervisor menu.



1) Press CUSTOMER SETUP button

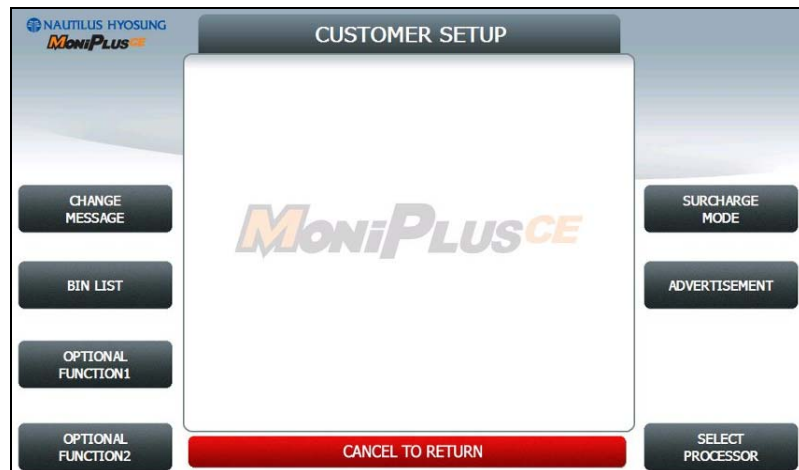

2) Press "ADVERTISEMENT" button



3) Press "TRANSACTION ADVERTISEMENT" button



5) You can enable or disable transaction dvertisement images to view by pressing “SCREEN” Key.



7.5.3 Making MoniView update media

All supported image format refer to "Supported Image Format"

- 1) Make "PATCH" folder.
- 2) Copy "UpdateInfo.dat" to under "PATCH" folder. (Optional)
- 3) Make "ADVERTISEMENT" folder in the "PATCH" folder.
- 4) Make "1024_600" (NH2700) / "800_600" (NH1800SE) folder in "ADVERTISEMENT" folder.
- 5) Copy all image files to under "1024_600" (NH2700) / "800_600" (NH1800SE) folder.
(check the file name)
- 6) Make compressed file like the below layout.

The following picture describe the layout of Zip file

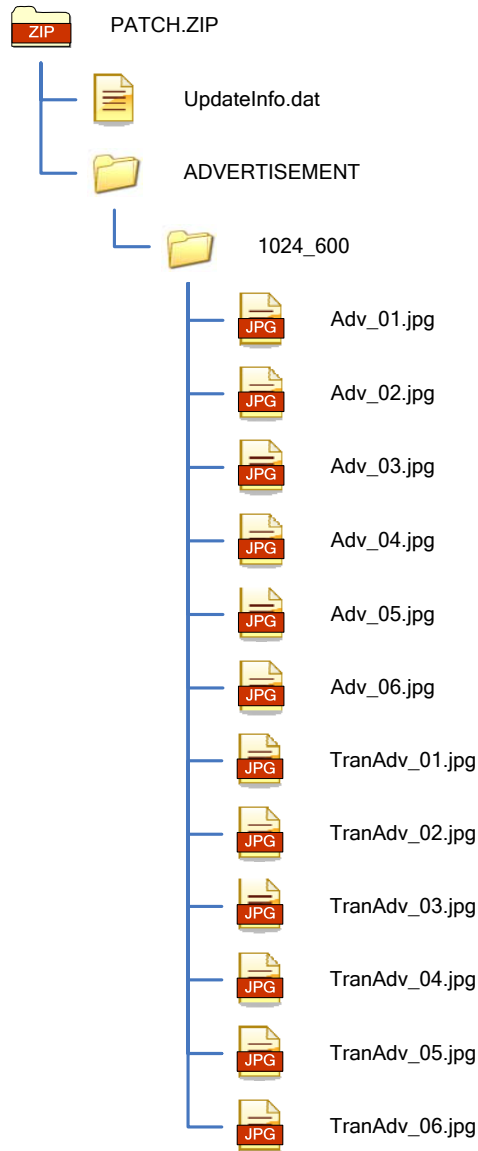

And you can download the “Patch.zip” using MoniView.

(If you have NH1800SE, you can see the same layout except “1024_600” folder. “1024_600” folder is replaced “800_600” folder.)

7.6 Background Image Update Guide

7.6.1 Preparation

Software Update function in Nautilus Hyosung's Windows CE Machine is applicable to update advertisement images.

7.6.1.1 Supported Image Format

The following table describe the supporting format of change background image

Model	Image Size	DPI	Color	File Format	Max Size (one image)
NH-2700	1024 X 600	72	24bit color	JPEG	300KB
NH-1800SE	800 X 600	72	24bit color	JPEG	300KB

The following table describe the file name and path of advertisement images. The path in blow table indicates image size is 1024 X 600

Background	File Name	Path
Screen #1	Back_1.jpg	\ATM\Screen\Backs\1024_600\Function (F/K) \ATM\Screen\Backs\1024_600\Touch (Touch) \ATM\Screen\Backs\800_600\Function (NH1800SE)
Screen #2	Back_2.jpg	\ATM\Screen\Backs\1024_600\Function (F/K) \ATM\Screen\Backs\1024_600\Touch (Touch) \ATM\Screen\Backs\800_600\Function (NH1800SE)
Screen #3	Back_3.jpg	\ATM\Screen\Backs\1024_600\Function (F/K) \ATM\Screen\Backs\1024_600\Touch (Touch) \ATM\Screen\Backs\800_600\Function (NH1800SE)
Screen #4	Back_4.jpg	\ATM\Screen\Backs\1024_600\Function (F/K) \ATM\Screen\Backs\1024_600\Touch (Touch) \ATM\Screen\Backs\800_600\Function (NH1800SE)
Screen #5	Back_5.jpg	\ATM\Screen\Backs\1024_600\Function (F/K) \ATM\Screen\Backs\1024_600\Touch (Touch) \ATM\Screen\Backs\800_600\Function (NH1800SE)
Screen #6	Back_6.jpg	\ATM\Screen\Backs\1024_600\Function (F/K) \ATM\Screen\Backs\1024_600\Touch (Touch) \ATM\Screen\Backs\800_600\Function (NH1800SE)

7.6.1.2 Updating your own UpdateInfo.dat (Optional)

Background images are updated using the software update program. While updating program proceeds, a line of message shows up in the main screen. If you want to change the message, just edit UpdateInfo.dat. The message length is up to 40 characters. A sample content is as follows. You can replace "A sample message.(V1.21)" to your own message.

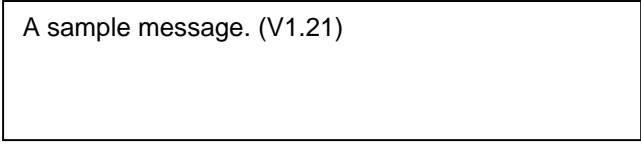

A sample message. (V1.21)

UpdateInfo.dat

7.6.1.3 Makeing SW Update media

- 1) Make "UPDATE" folder in the USB memory drive or the SD Card.
- 2) Make "NH2700CE" folder in the "UPDATE" folder.
- 3) Make "PATCH" folder in the "NH2700CE" folder.
- 4) Copy "UpdateInfo.dat" to under "PATCH" folder. (Optional)
- 5) Make "SCREEN" folder in the "PATCH" folder.
- 6) Make "Backs" folder in "SCREEN" folder.
- 7) Make "1024_600"(NH2700) / "800_600"(NH1800SE) folder in "Backs" folder.
- 8) If ATM is function type, make "Function" folder in "1024_600"(NH2700) / "800_600"(NH1800SE) folder
- 9) If ATM is touch type, make "Touch" folder in "1024_600" folder (NH2700 Only)
- 10) Copy all image files to under "Function" or " Touch" folder.(check the file name)

The following picture describes the layout of the USB Drive or SD Card.

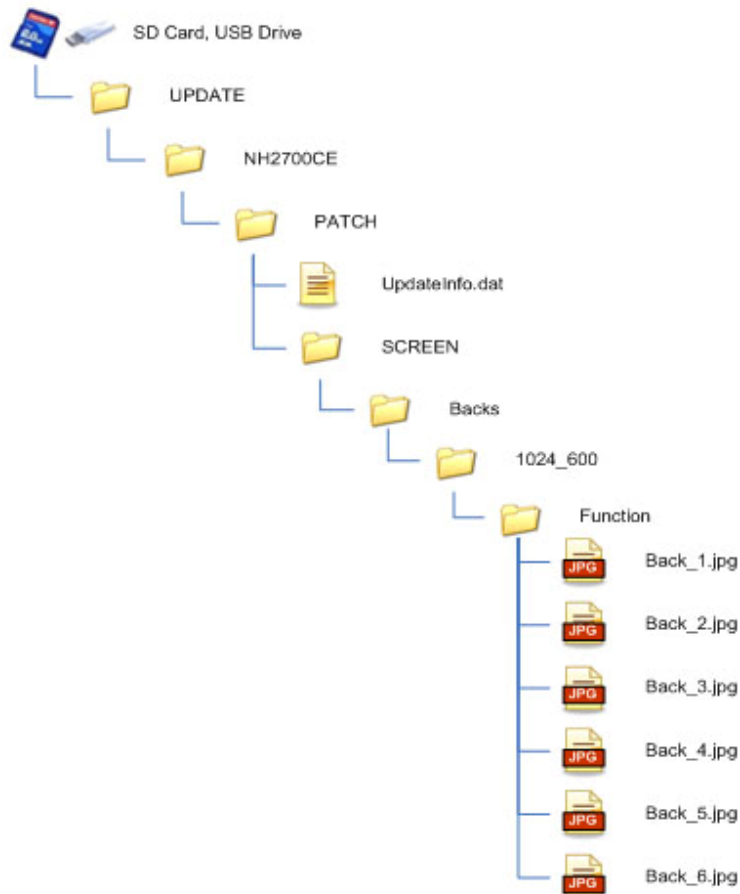

(If you have NH1800SE, you can see the same layout except "1024_600" folder. "1024_600" folder is replaced "800_600" folder.)

7.6.2 Execute updating

7.6.2.1 Software Update

Advertisement images can be installed or updated by Software Update tool in supervisor menu. You can update advertisement images by software downloading with MoinView server. Please refer to the MoinView manual for the detail downloading functionality.

1) Press SYSTEM SETUP button.



2) Press SYSTEM CONTROL button.

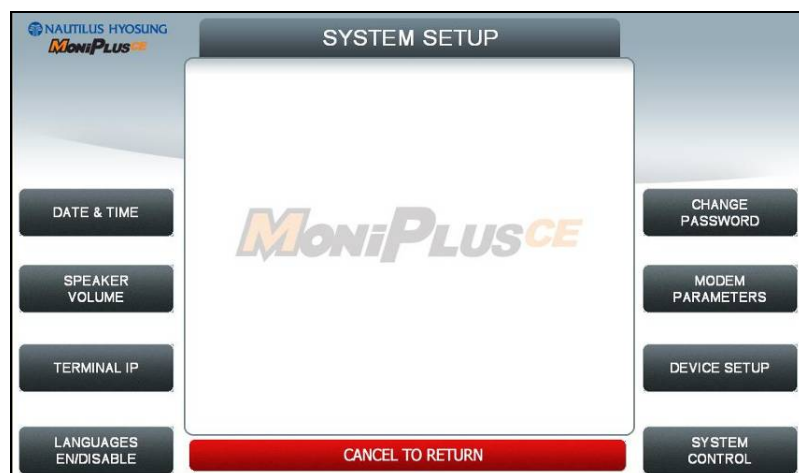

3) Plug the USB drive in USB slot and press left-top function key, "SOFTWARE UPDATE".



4) Press left function key, "YES".

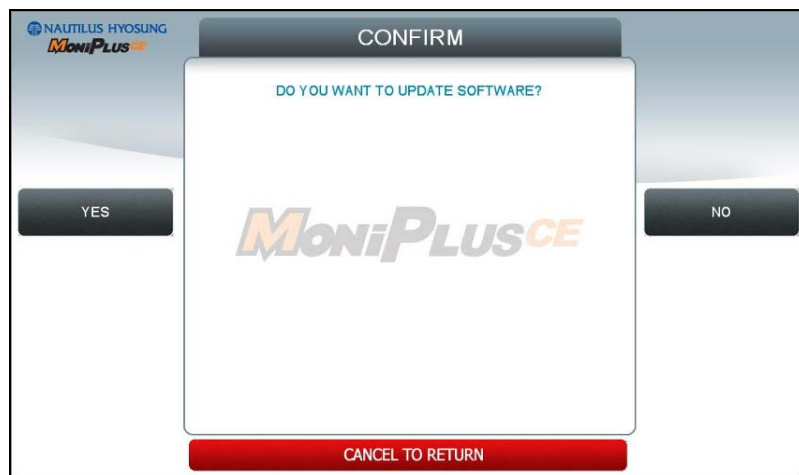

When "YES" button is selected, new software in USB drive is transferred to a dedicated directory(ATM) and ATM will start to reboot automatically.

7.6.2.2 Setup change background

You can set up change background option in the supervisor menu.



1) Press CUSTOMER SETUP button

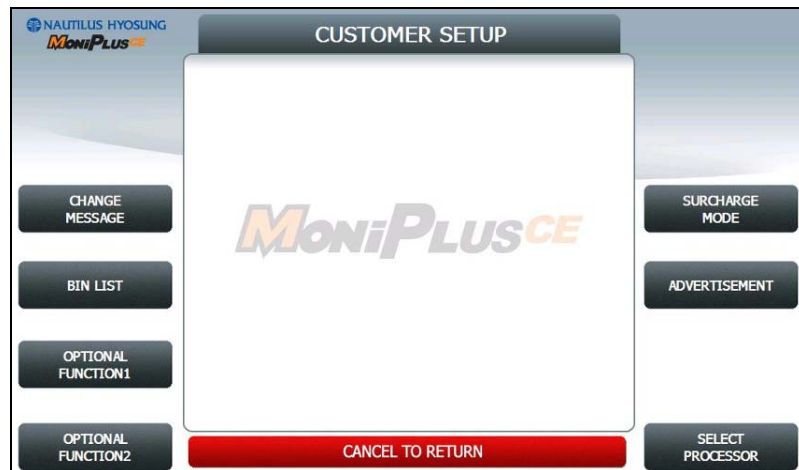

2) Press "OPTIONAL FUNCTION 2" button

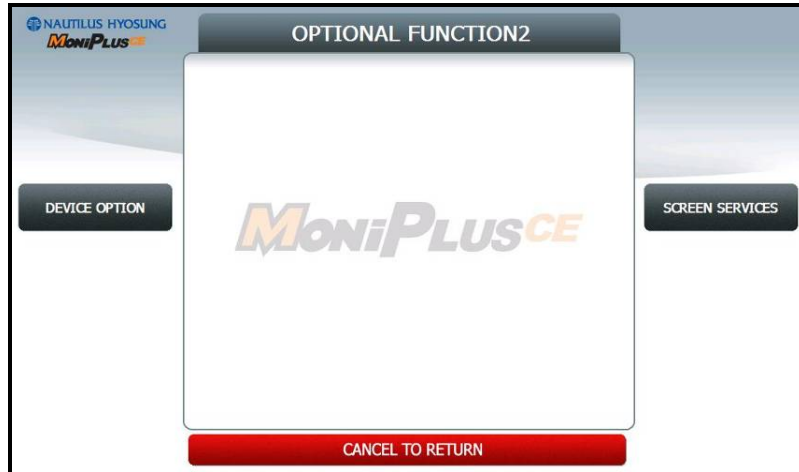

3) Press "SCREEN SERVICES" button

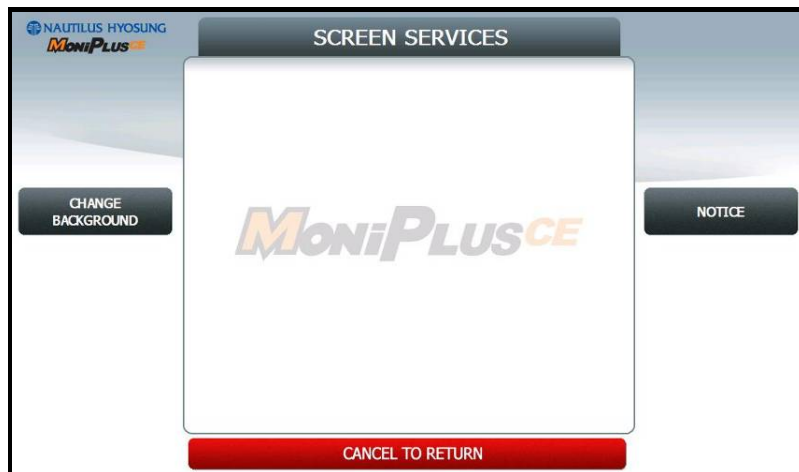

4) Press "CHANGE BACKGROUND" button

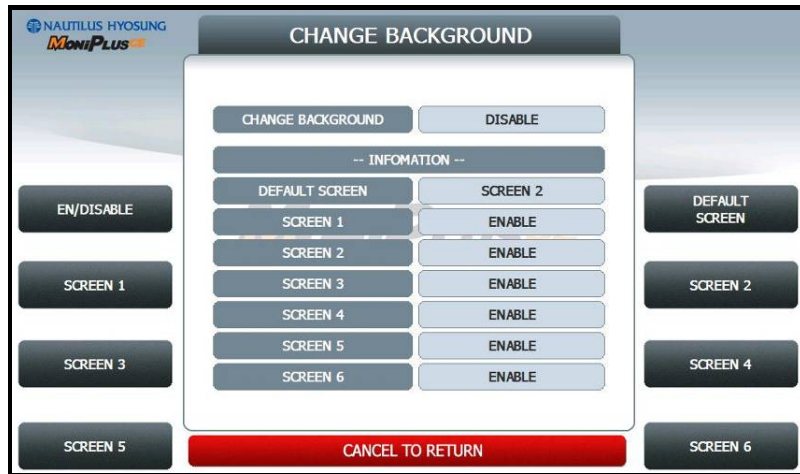

5) You can set up change background images to view by pressing "SCREEN" Key or "DEFAULT SCREEN".

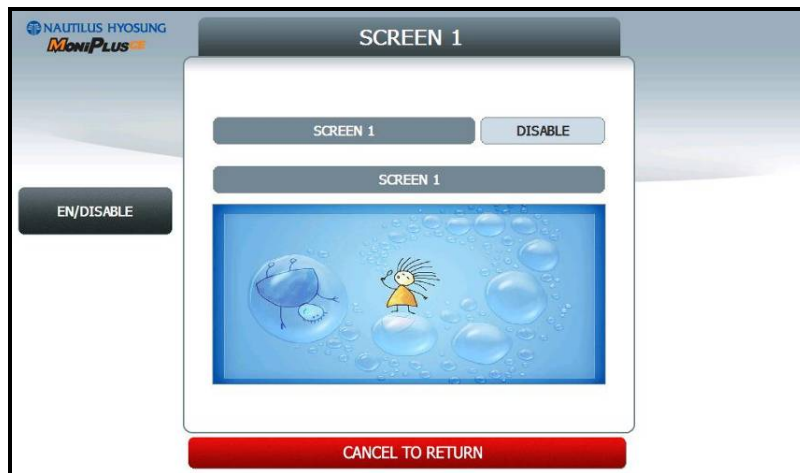

7.6.3 Making MoniView update media

All supported image format refer to “Supported Image Format”

- 1) Make “PATCH” folder.
- 2) Copy “UpdateInfo.dat” to under “PATCH” folder. (Optional)
- 3) Make “SCREEN” folder in the “PATCH” folder.
- 4) Make “Bacs” folder in “SCREEN” folder.
- 5) Make “1024_600”(NH2700) / “800_600”(NH1800SE) folder in “Bacs” folder.
- 6) If ATM is function type, make “Function” folder in “1024_600”(NH2700) / “800_600”(NH1800SE) folder
- 7) If ATM is touch type, make “Touch” folder in “1024_600” folder (NH2700 Only)
- 8) Copy all image files to under “Function” or “ Touch” folder.(check the file name)
- 9) Make comperessed file like the below layout.

The following picture describe the layout of Zip file

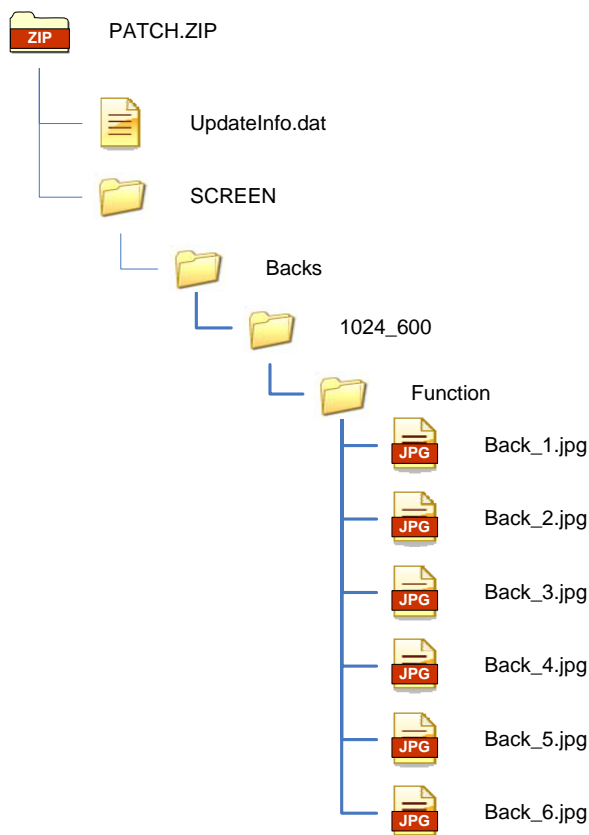

And you can download the “Patch.zip” using MoniView.

7.7 Weather Service Guide (NH2700 Only)

ATM from the idle screen, a feature that will display weather information.

Weather information set up and updated only by MoniView, ATM displaying weather information for today and tomorrow that gives

How to register and update detailed weather information, please see the manual of MoniView.

Ex) Weather Service Display Screen

